

HOT SHOT! VIDEO COASTER ALTERNATE BUILD

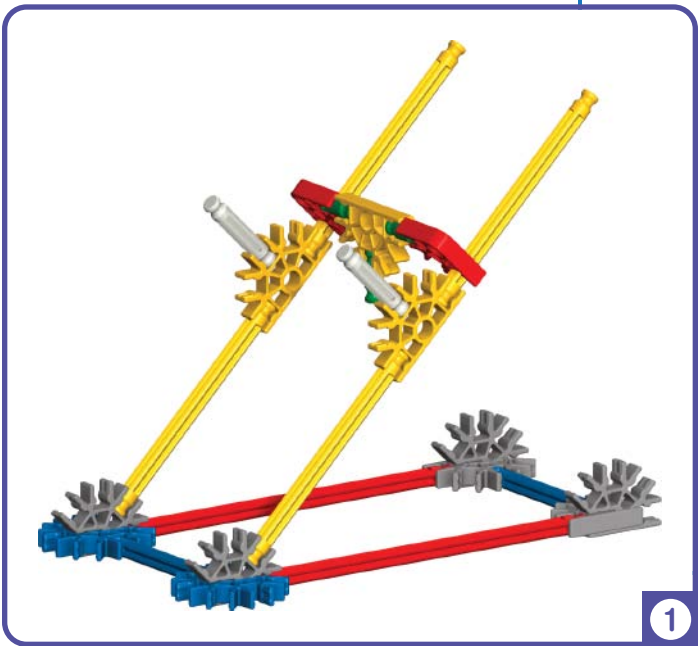

Did you install 2 AA (or LR6) batteries in the motor?

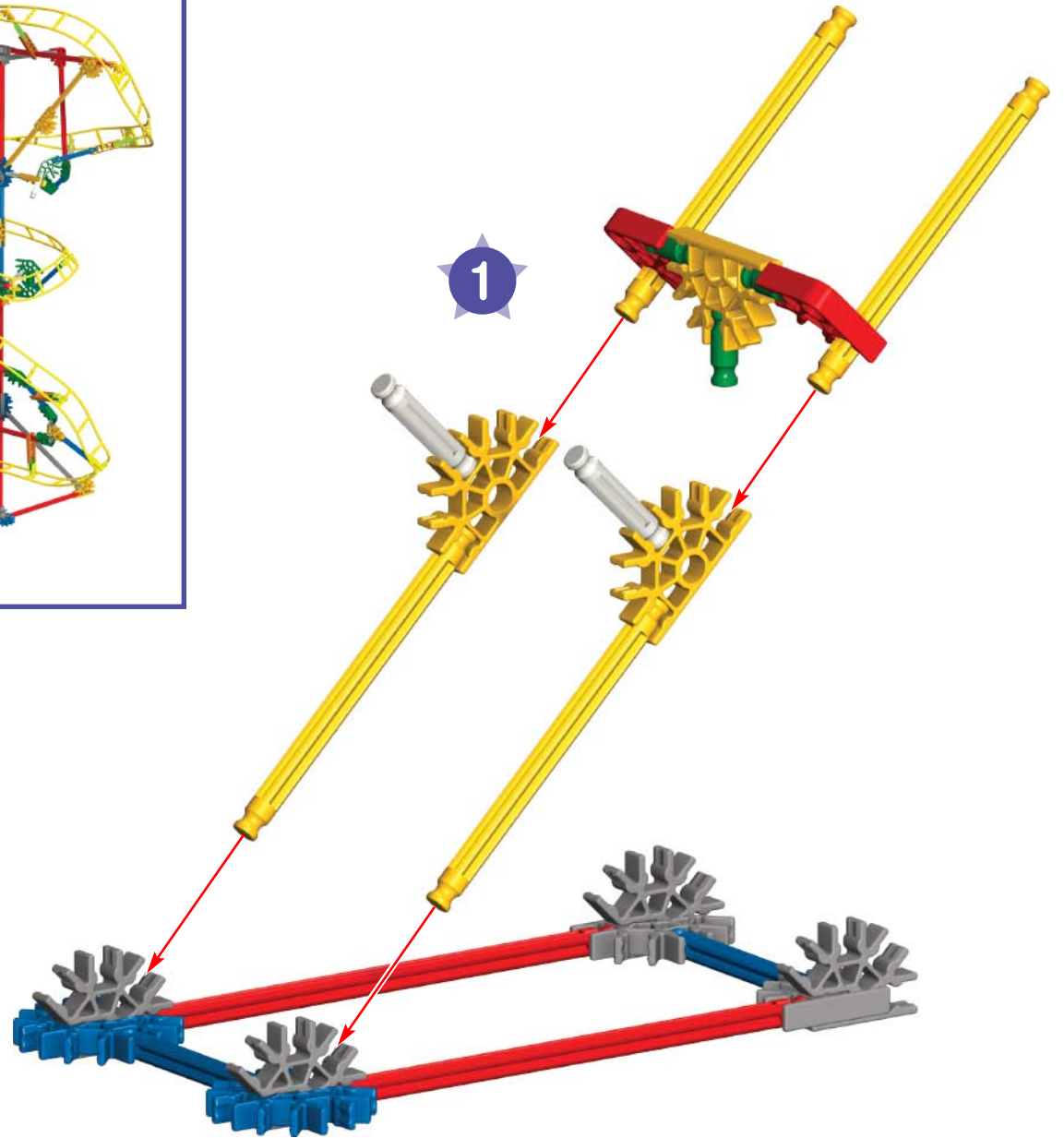

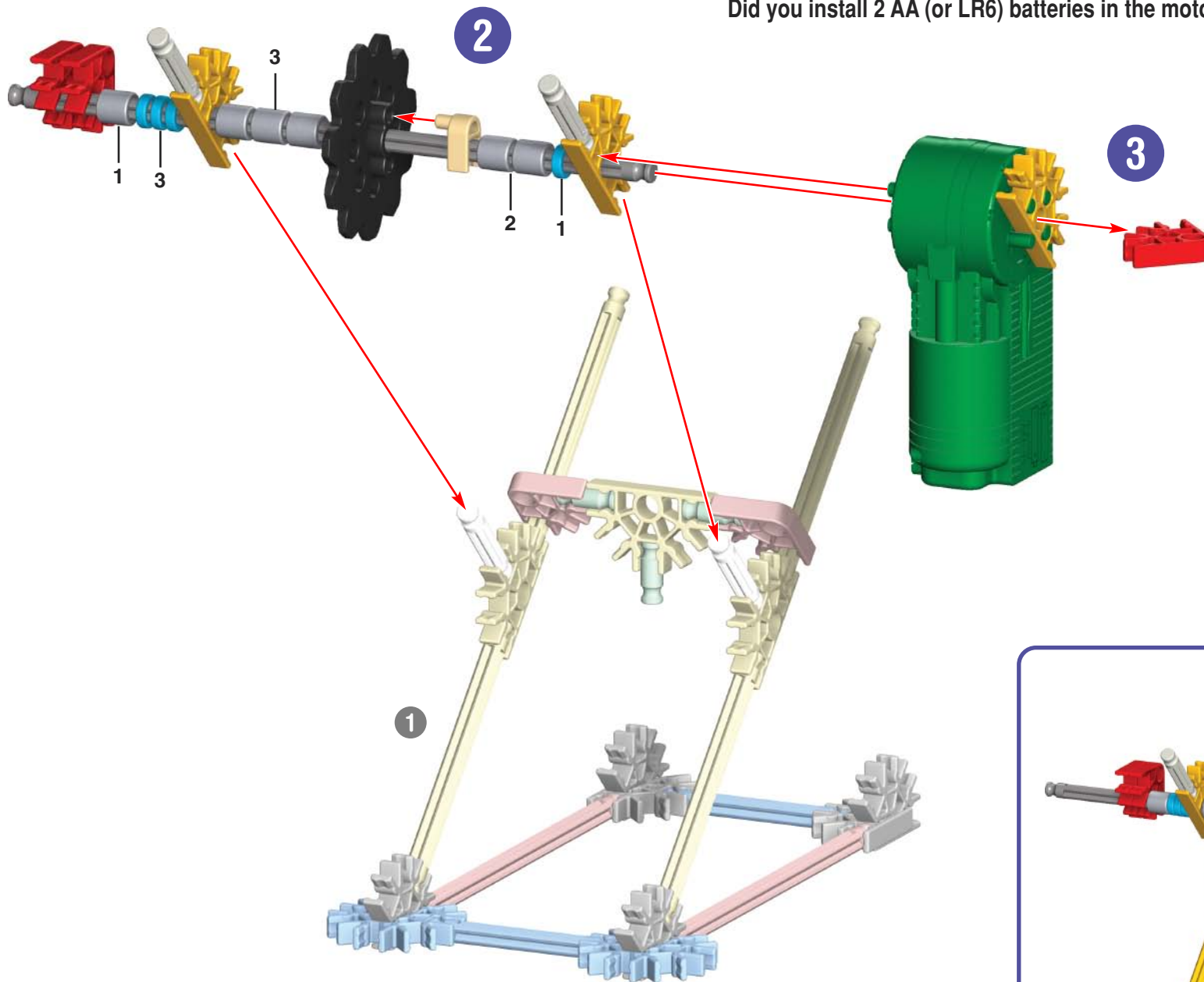
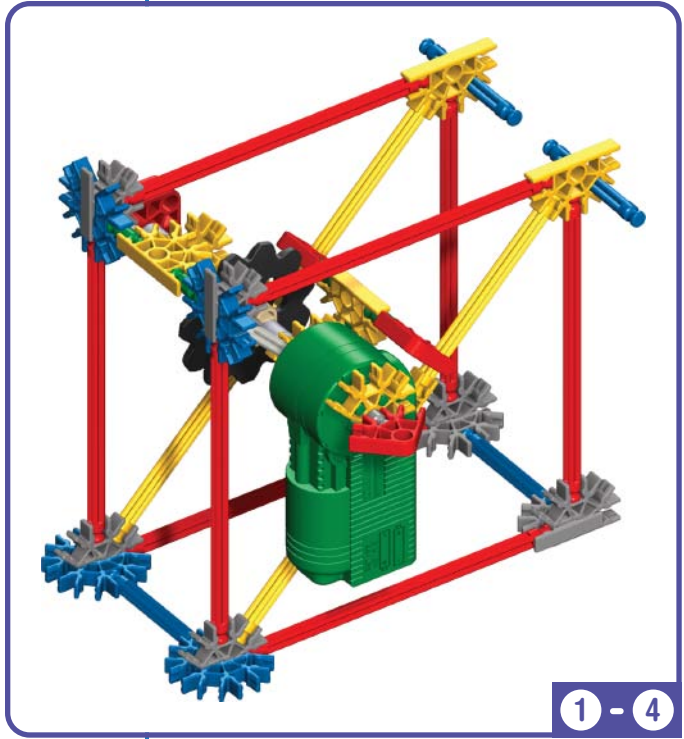
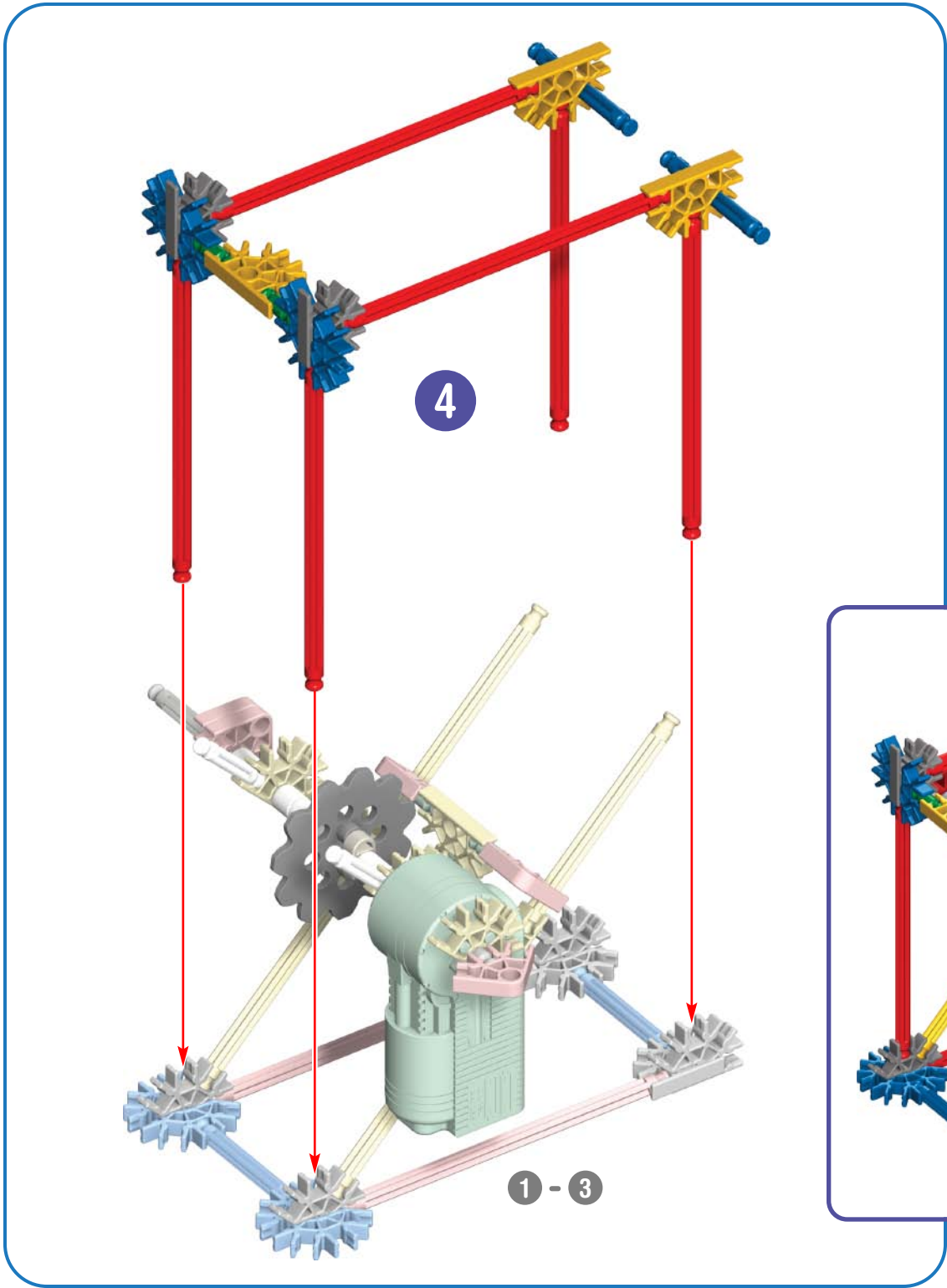

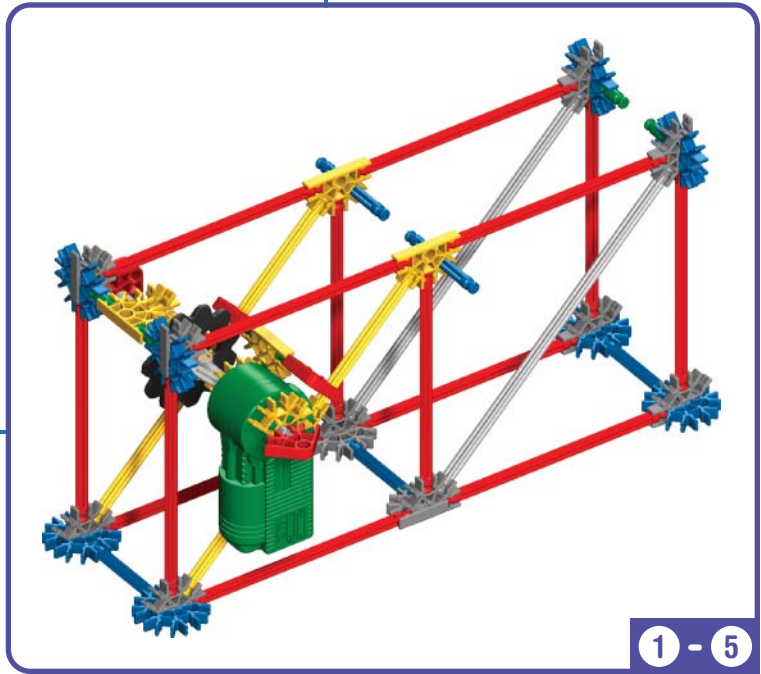
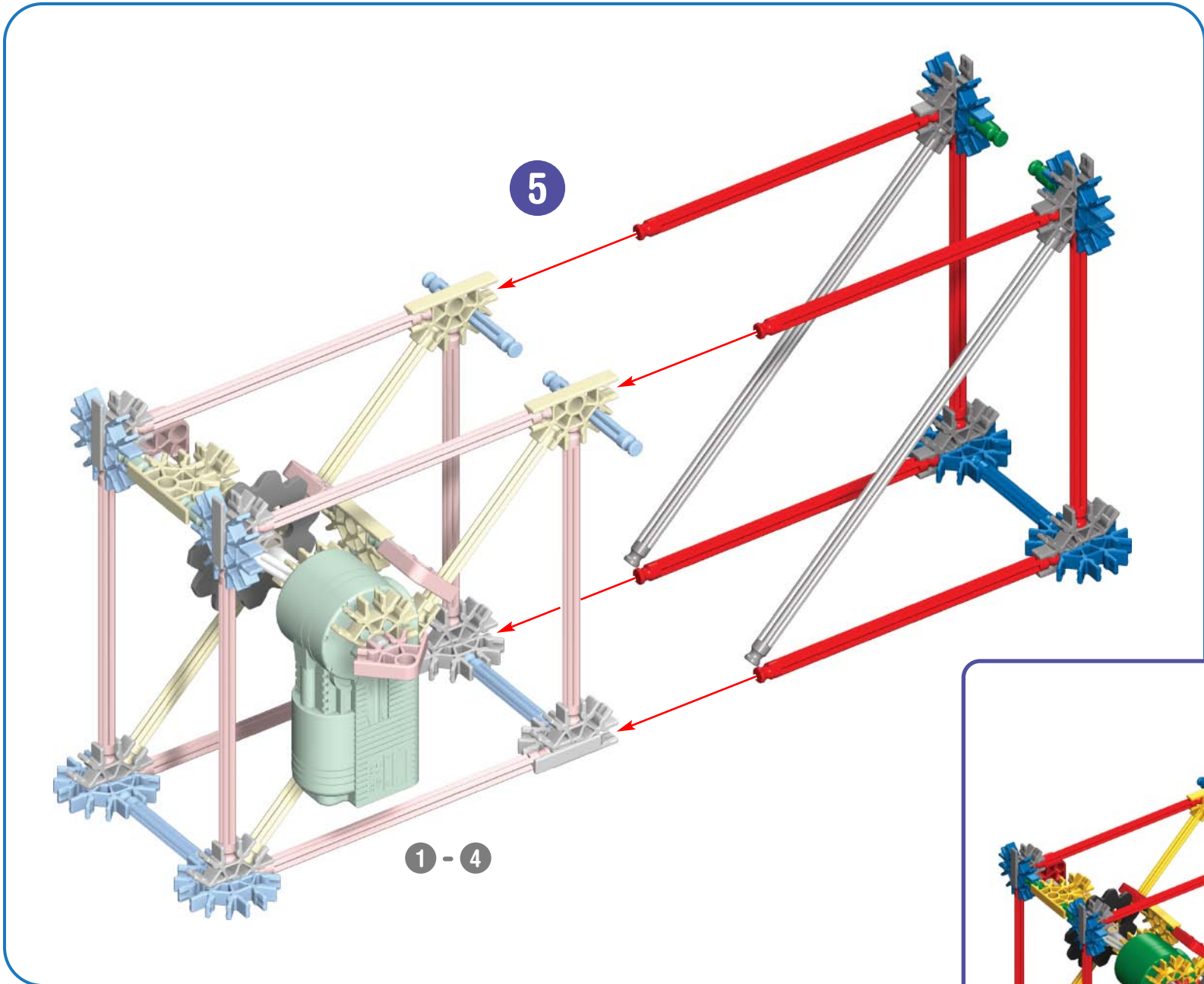

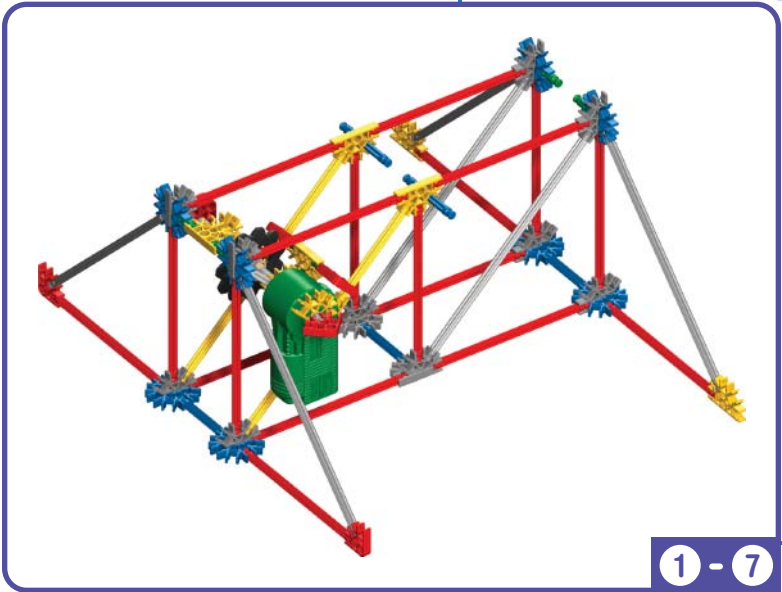
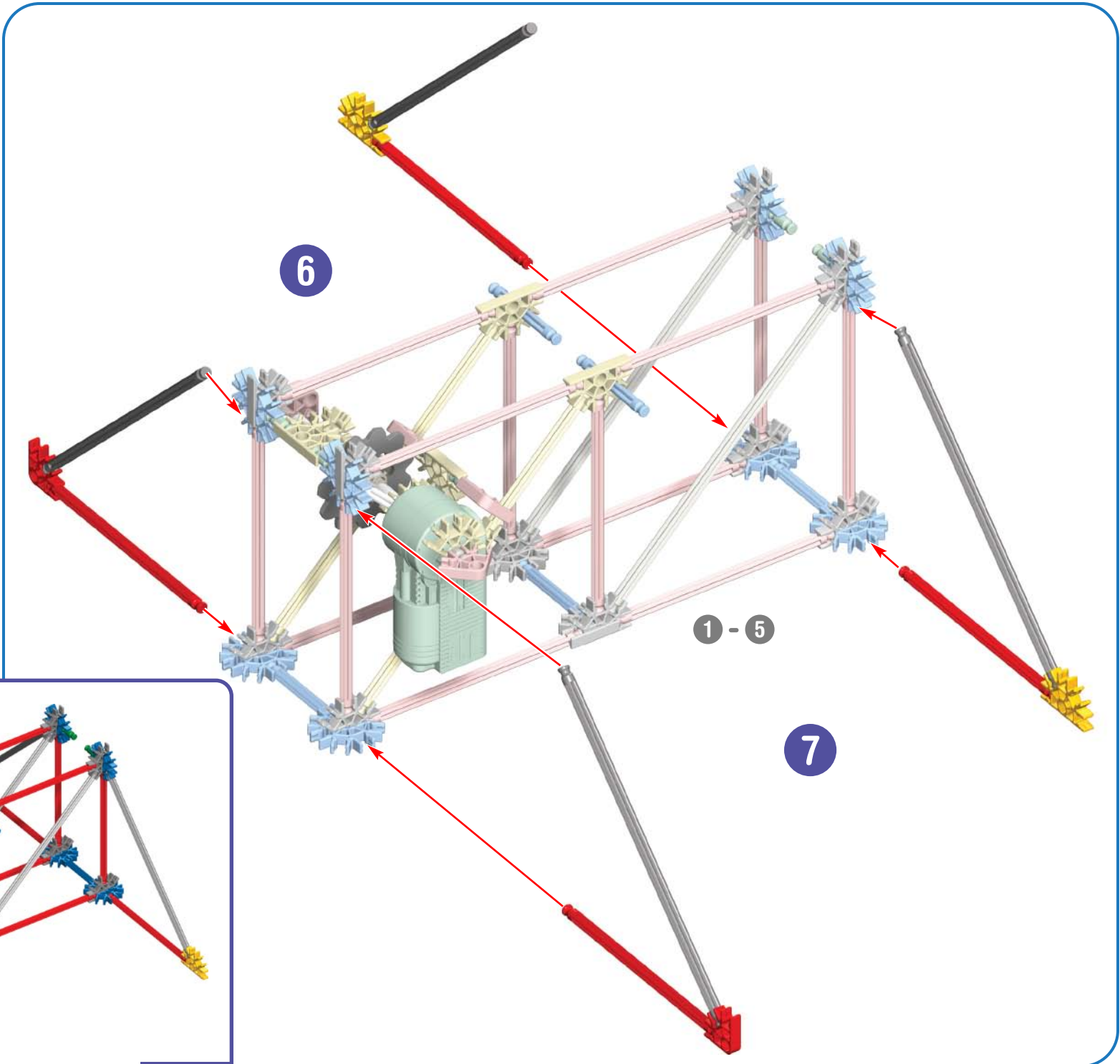

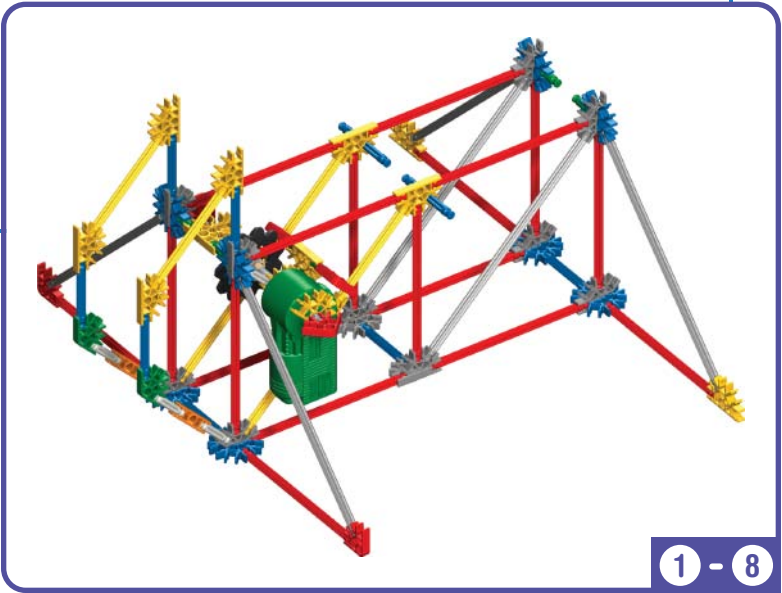
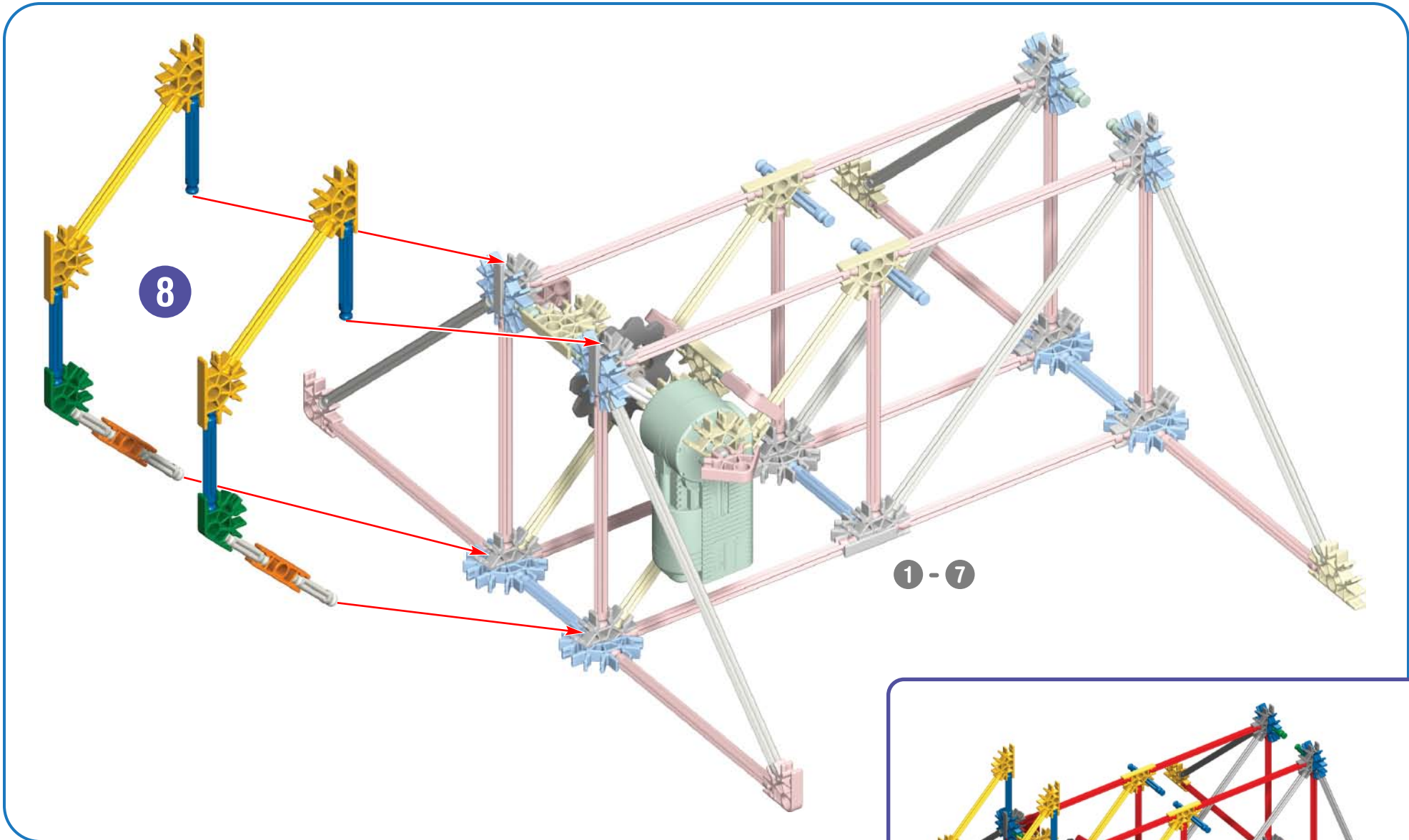

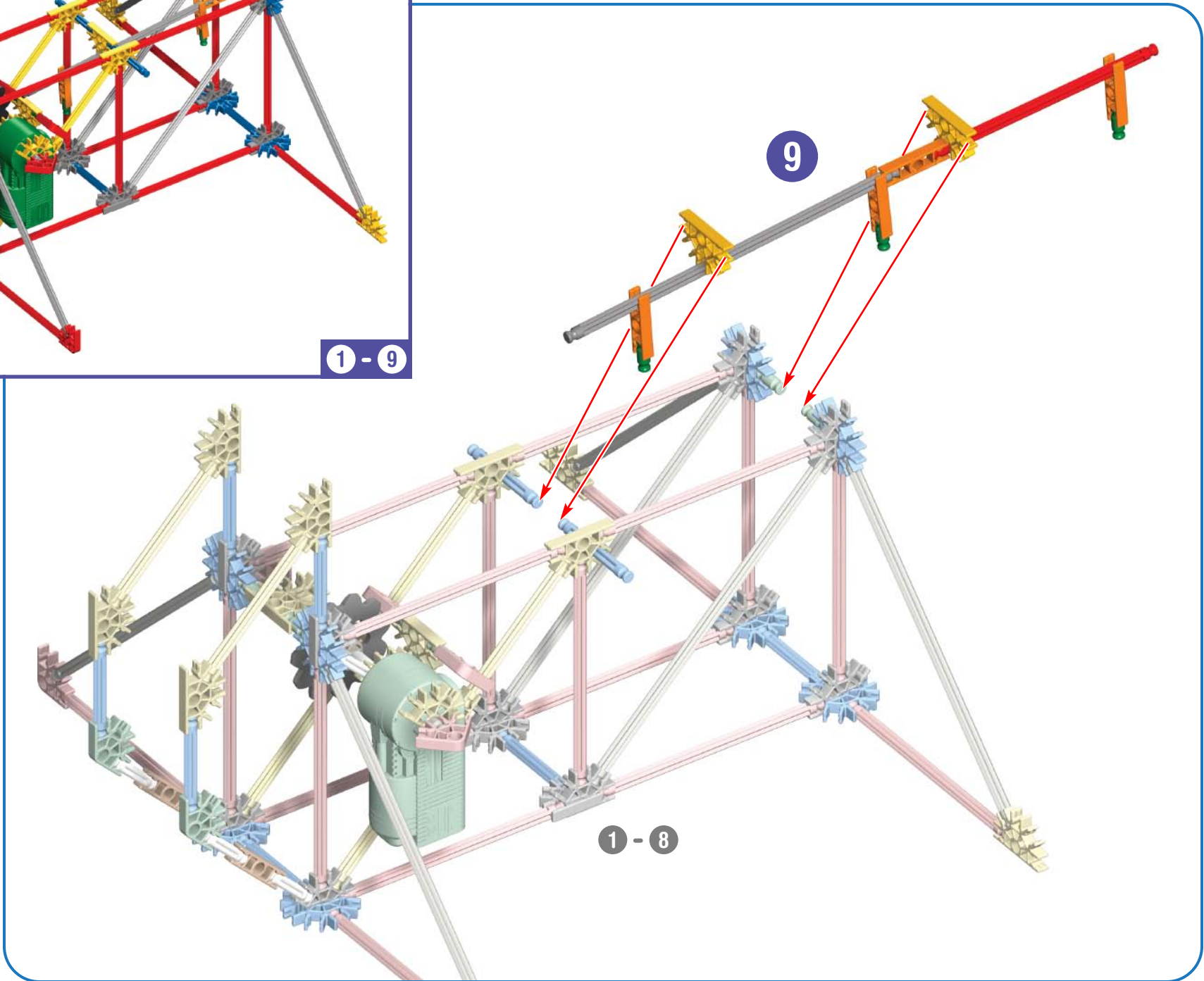
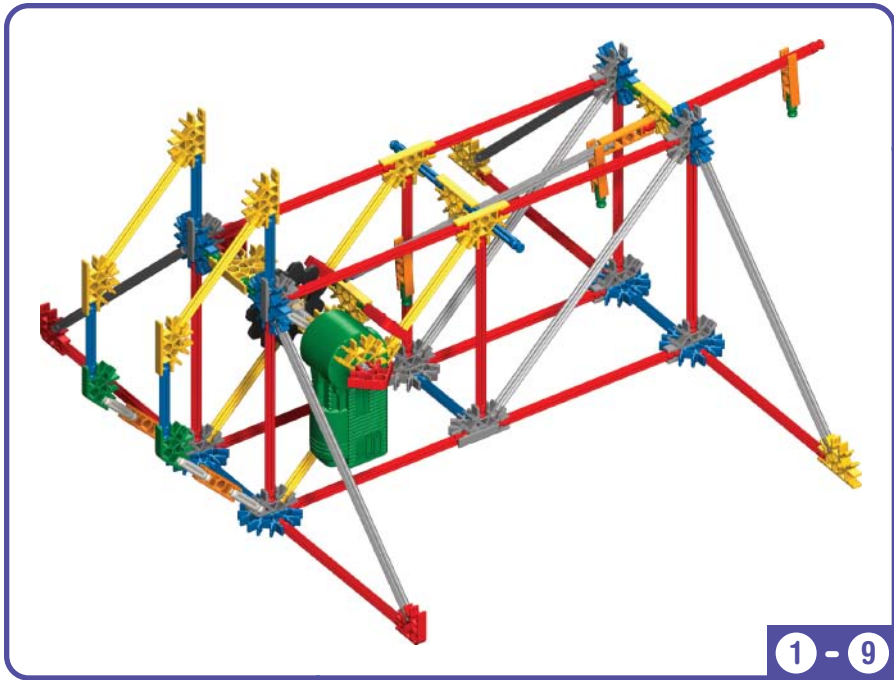

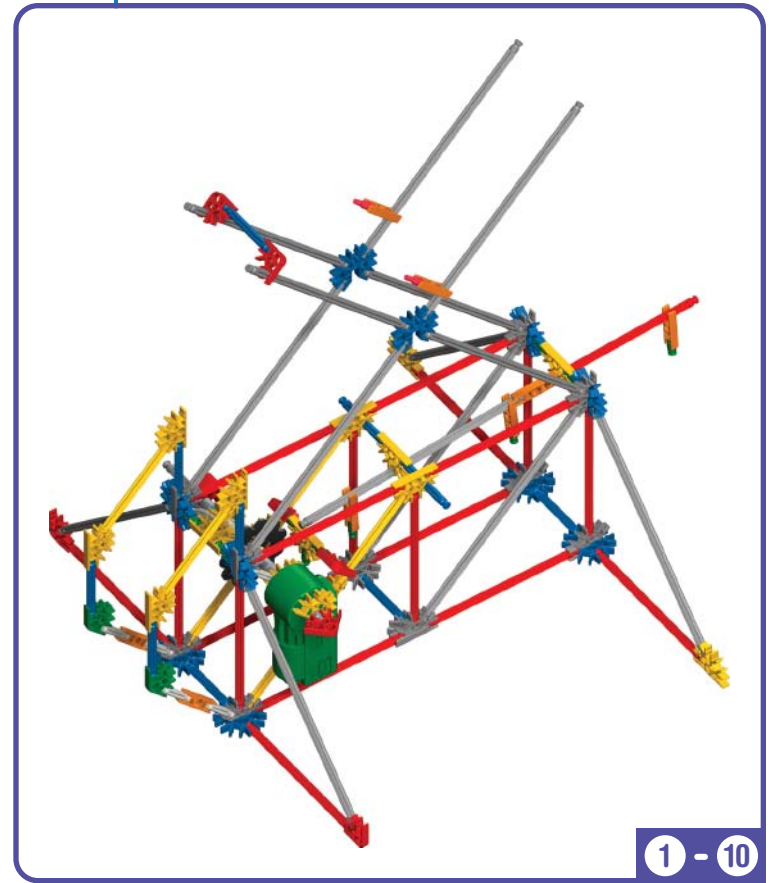
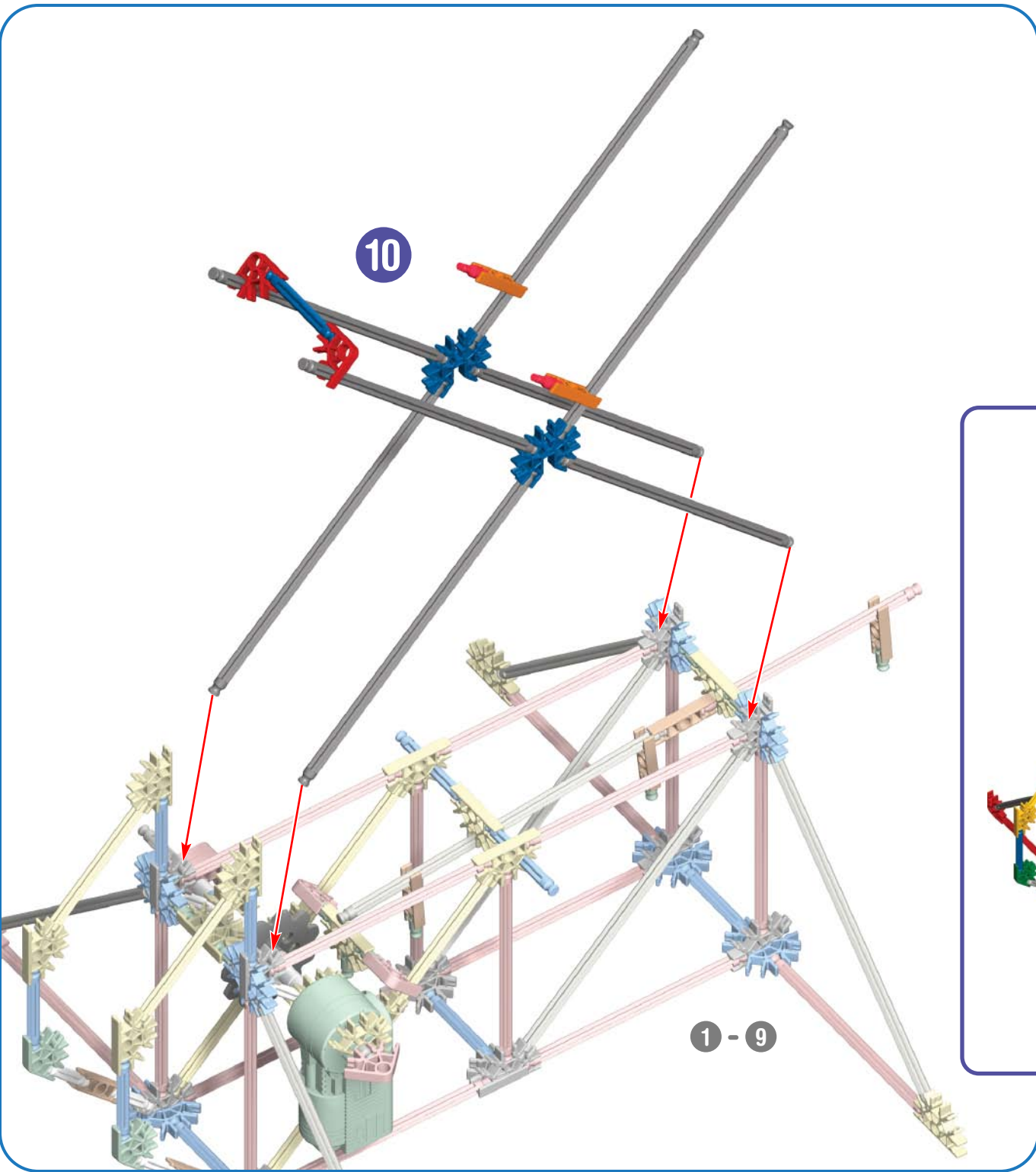

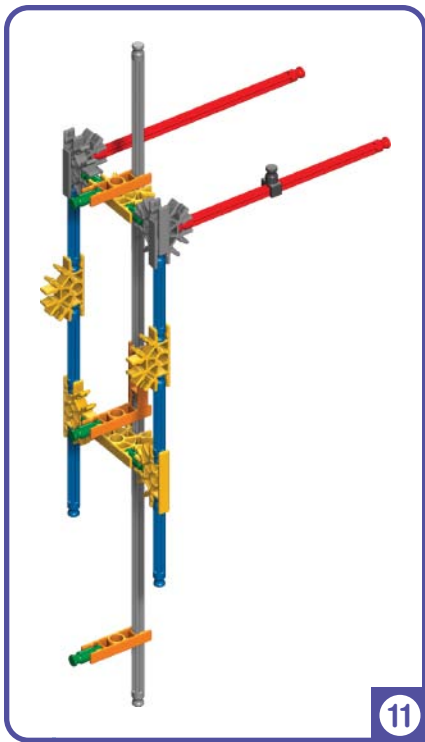

11

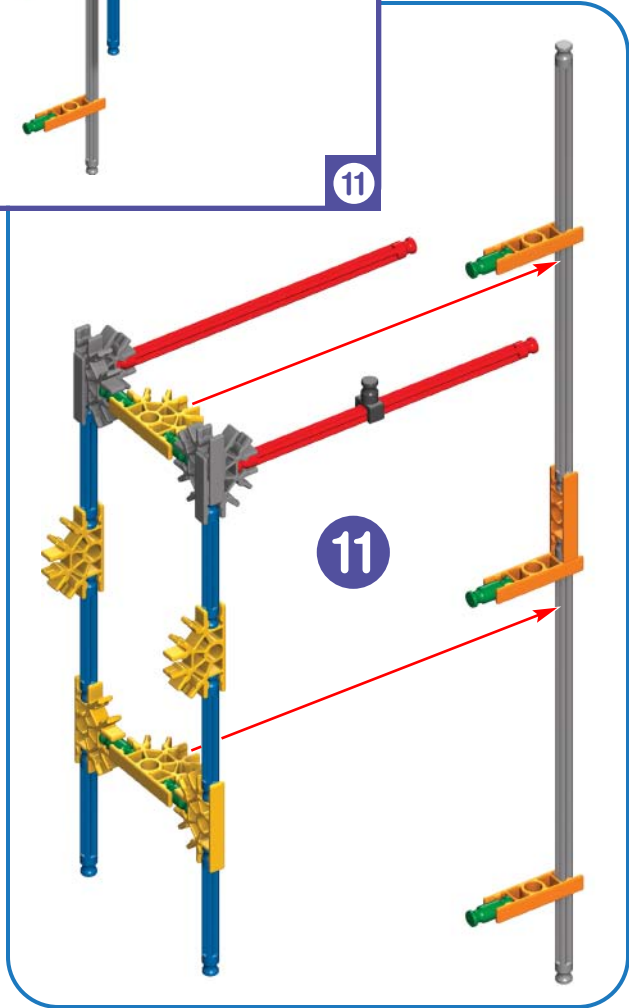

11

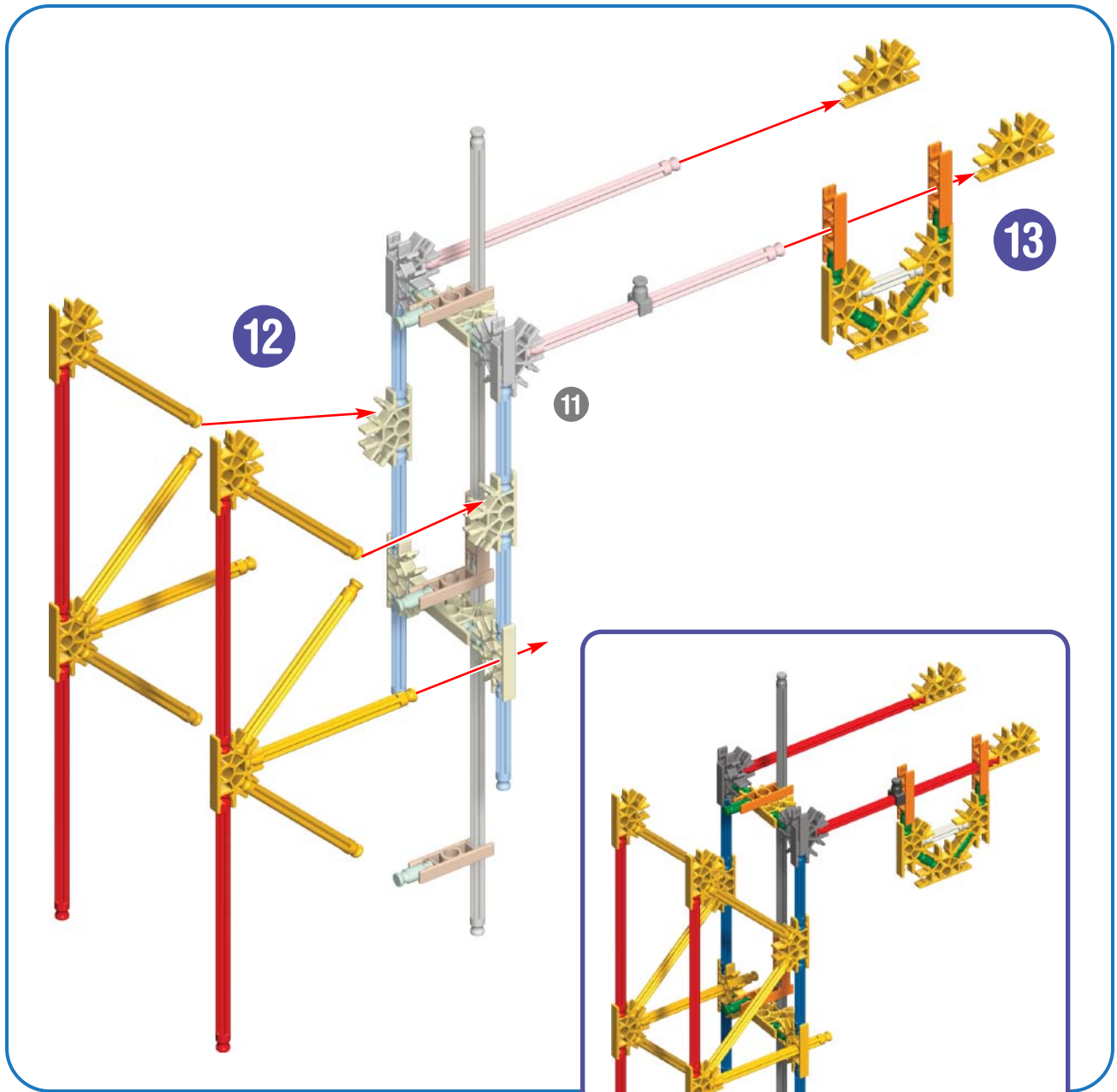

12

11

13

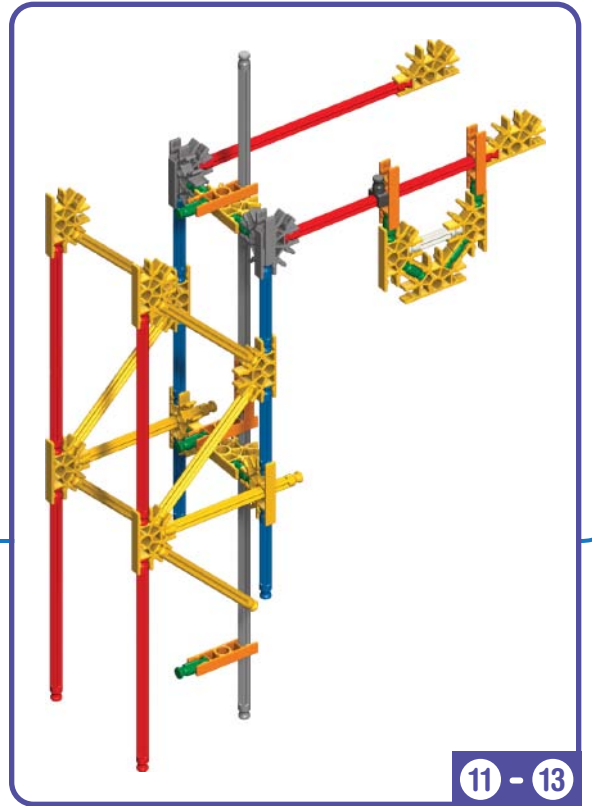

11 - 13

11 - 13

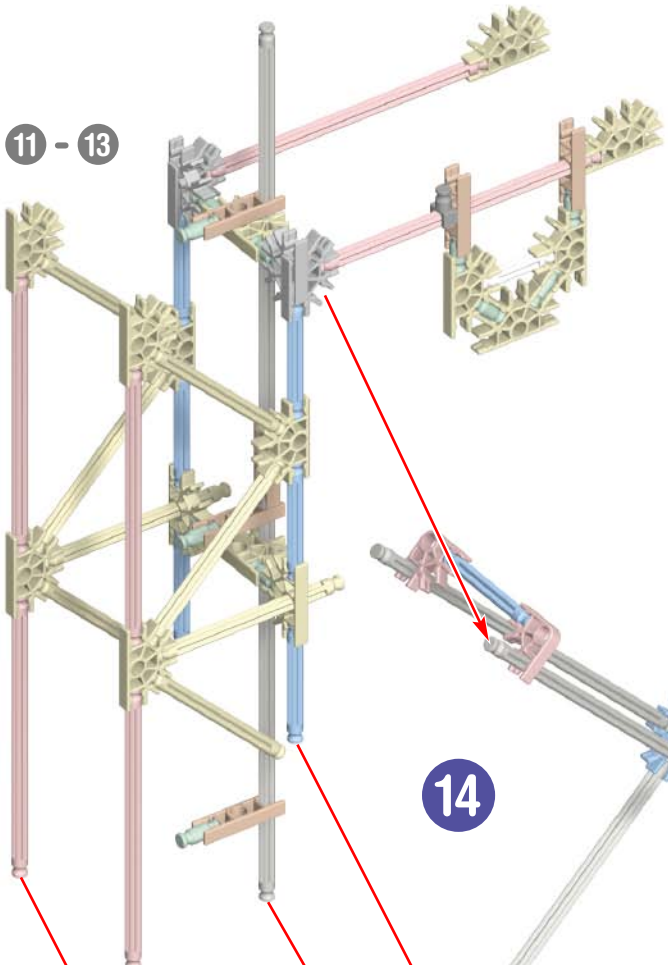

14

1 - 10

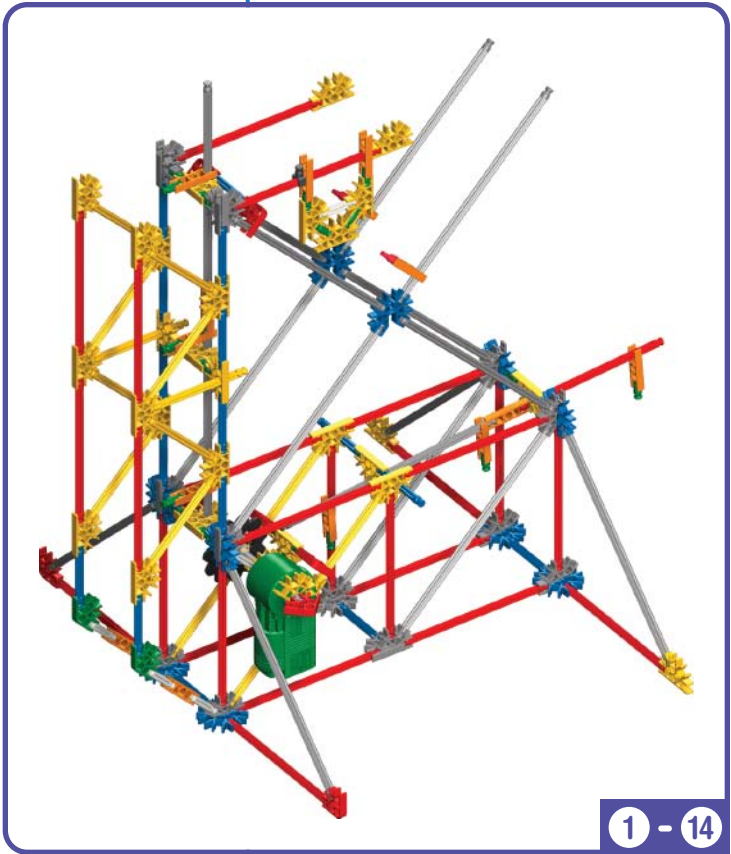
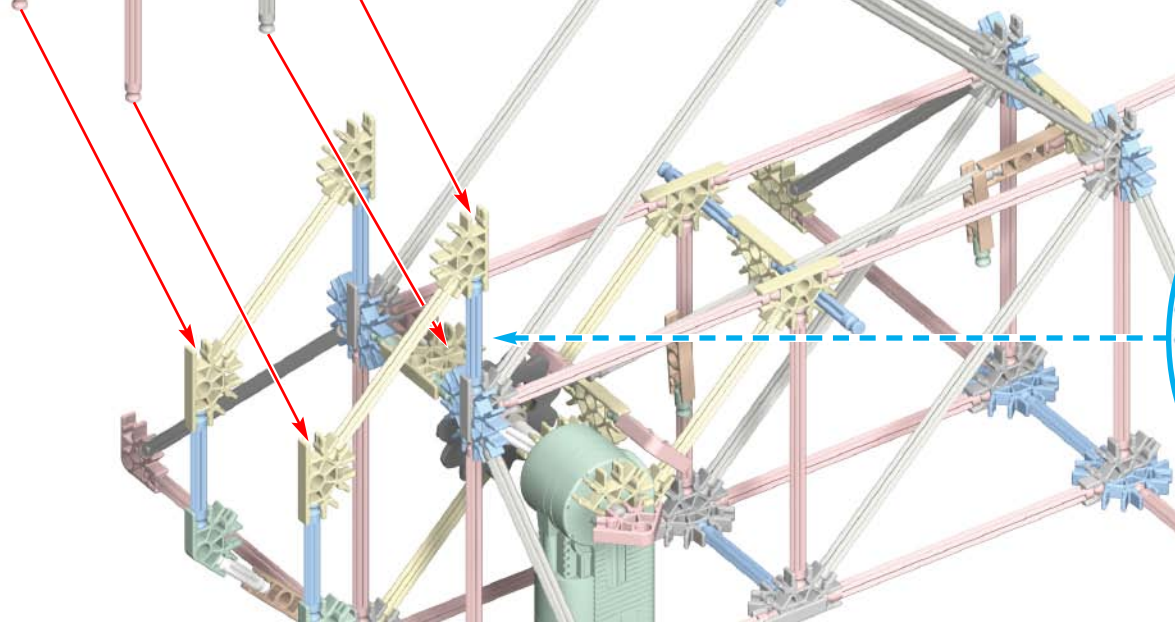

1 - 14

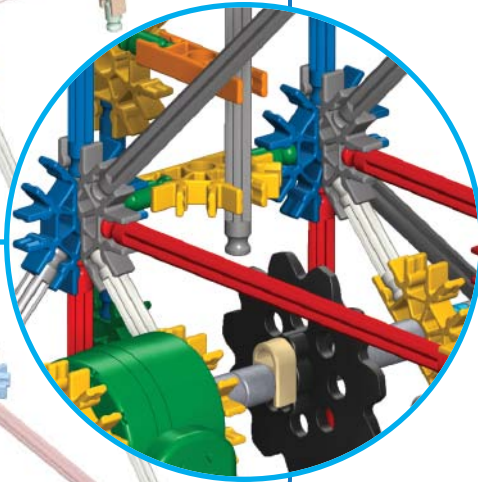

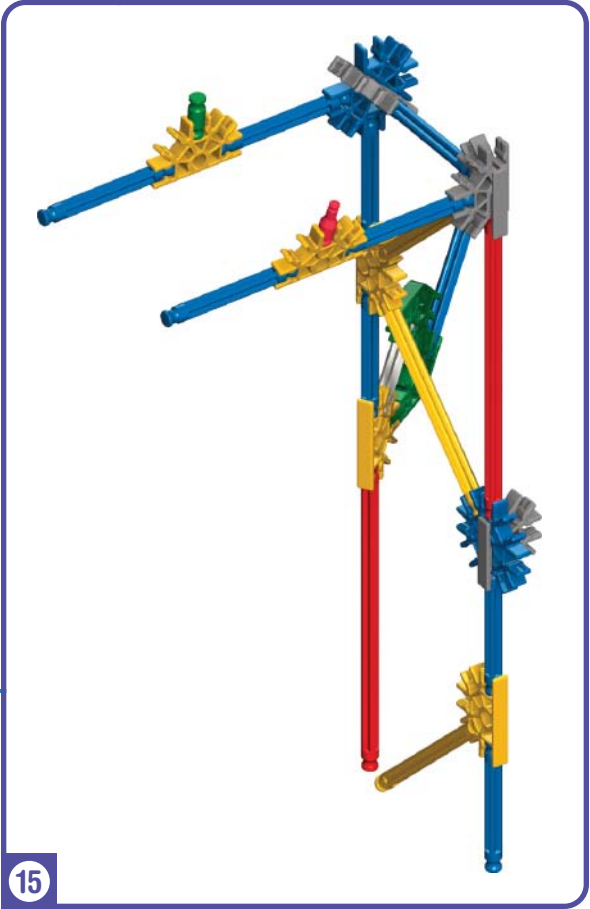
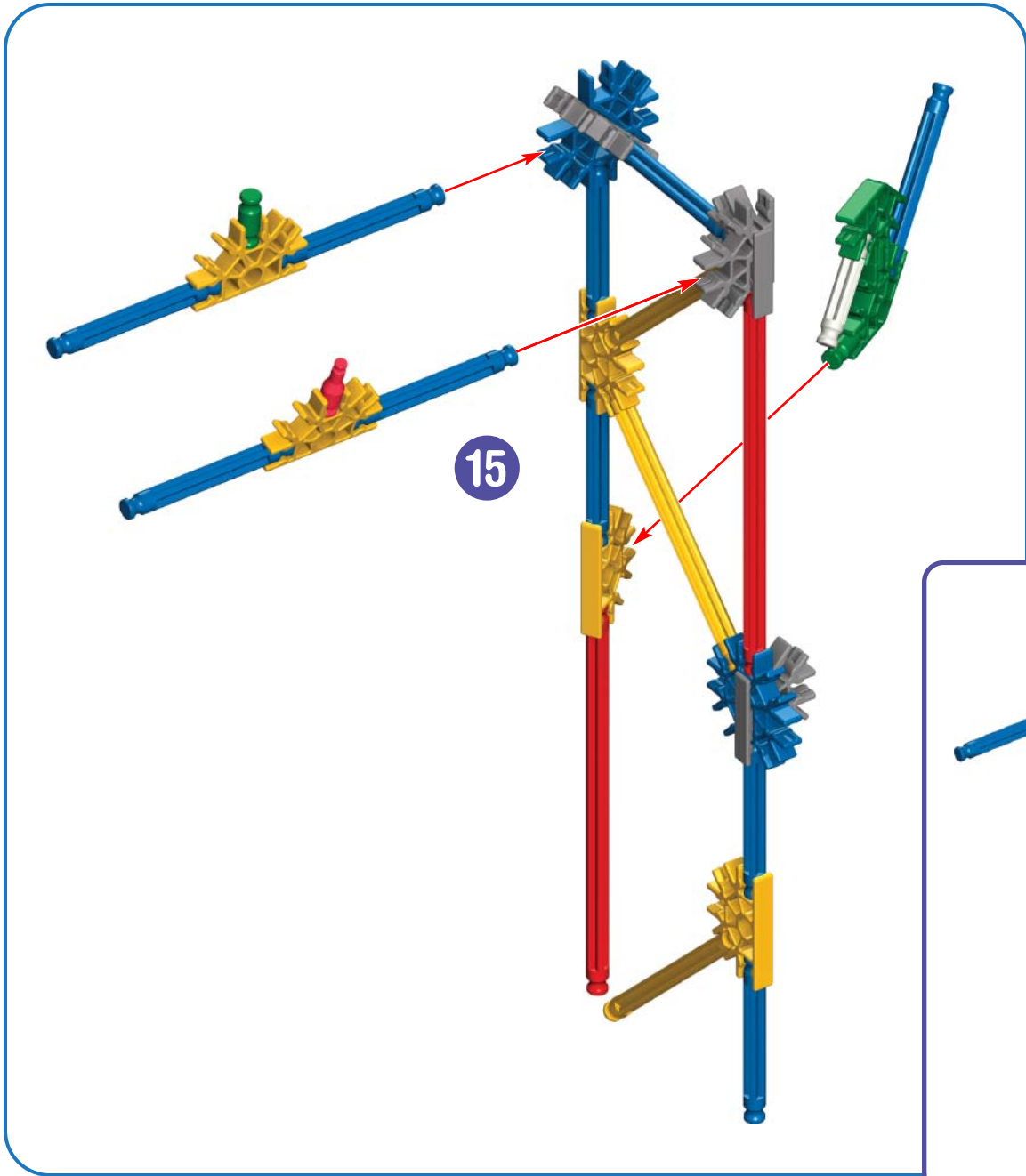

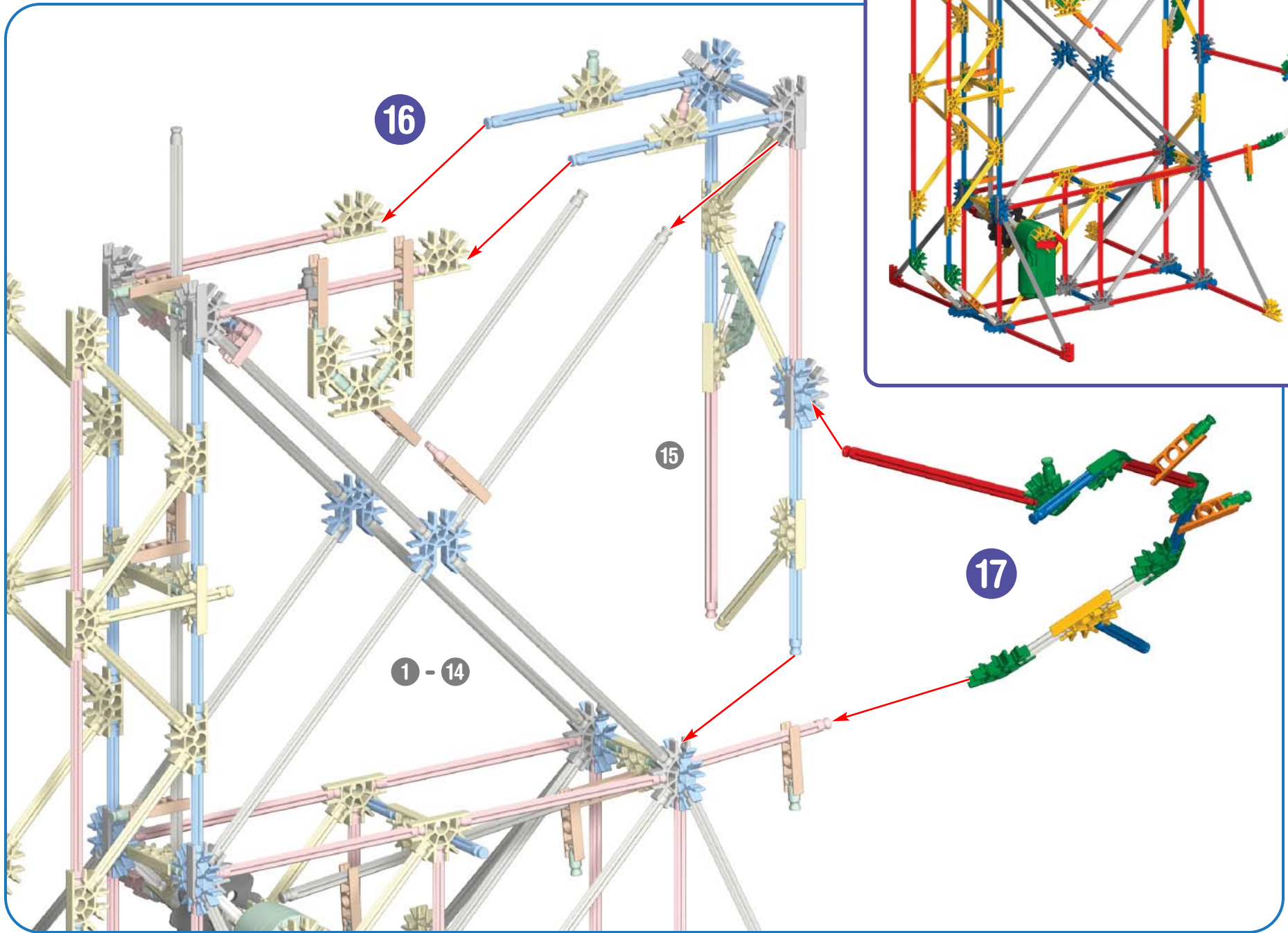

16

15

1 - 14

17

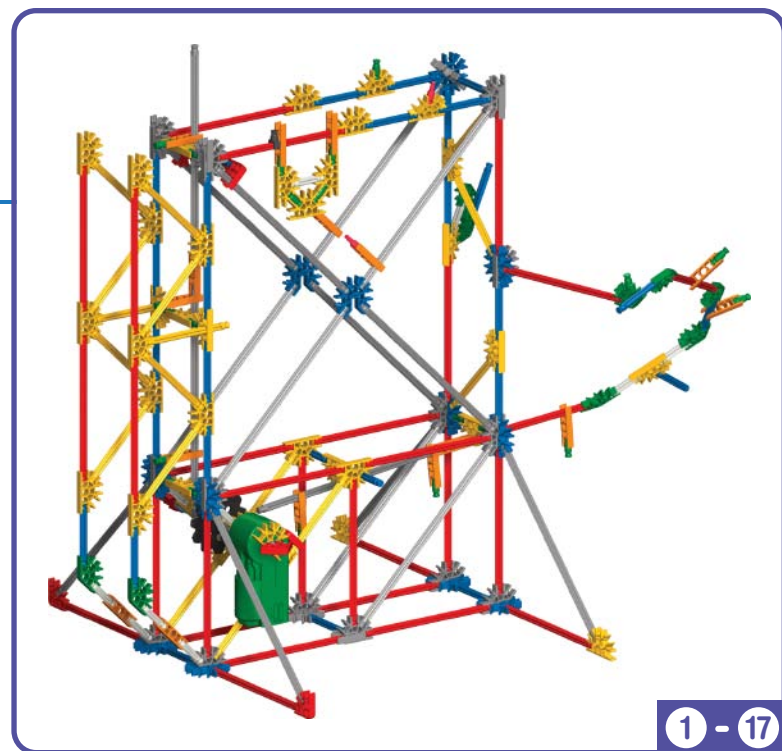

1 - 17

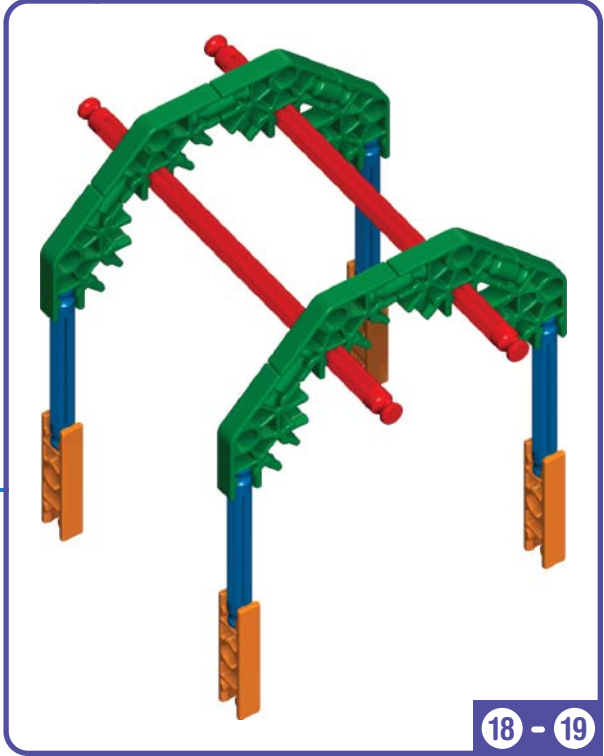
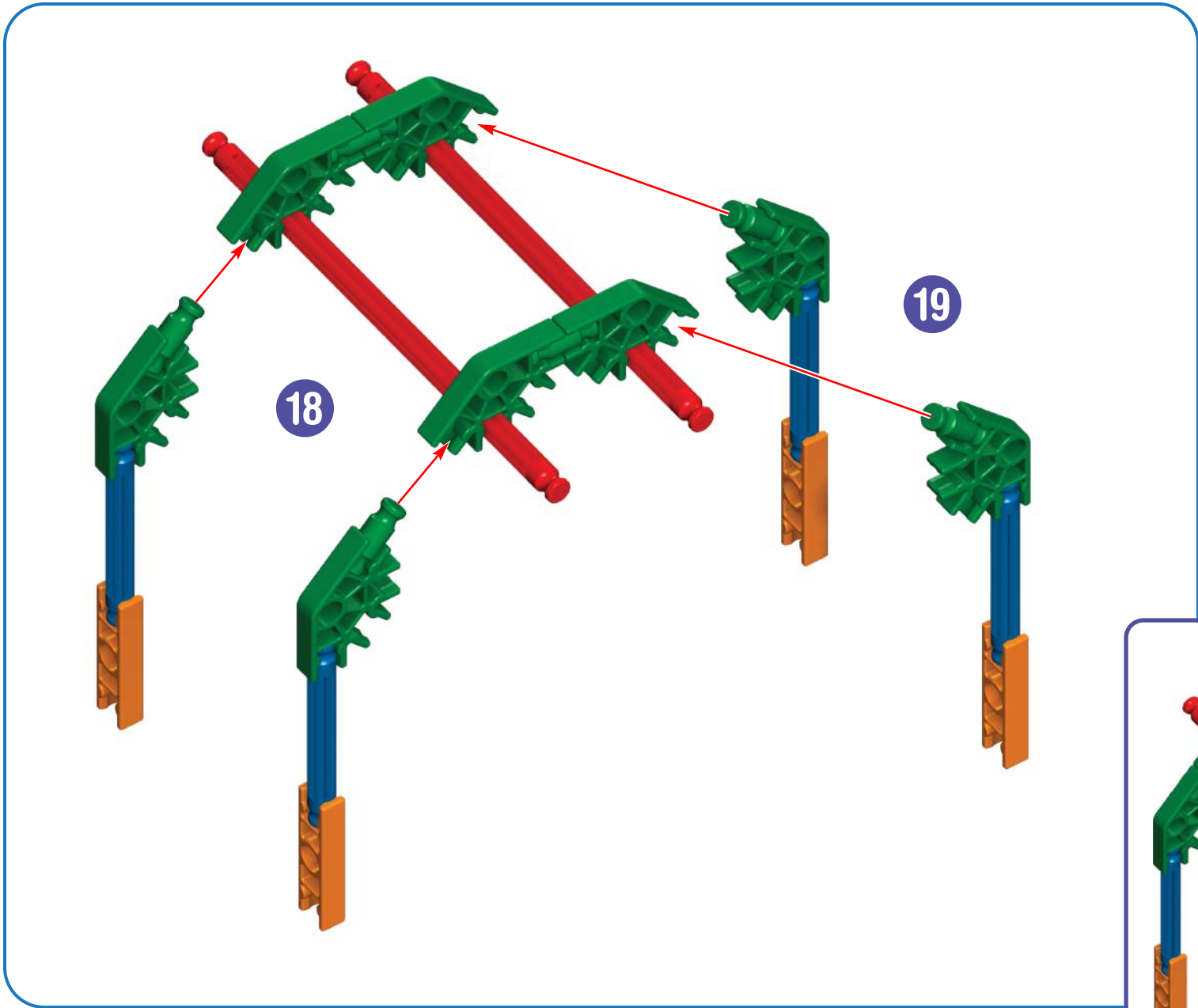

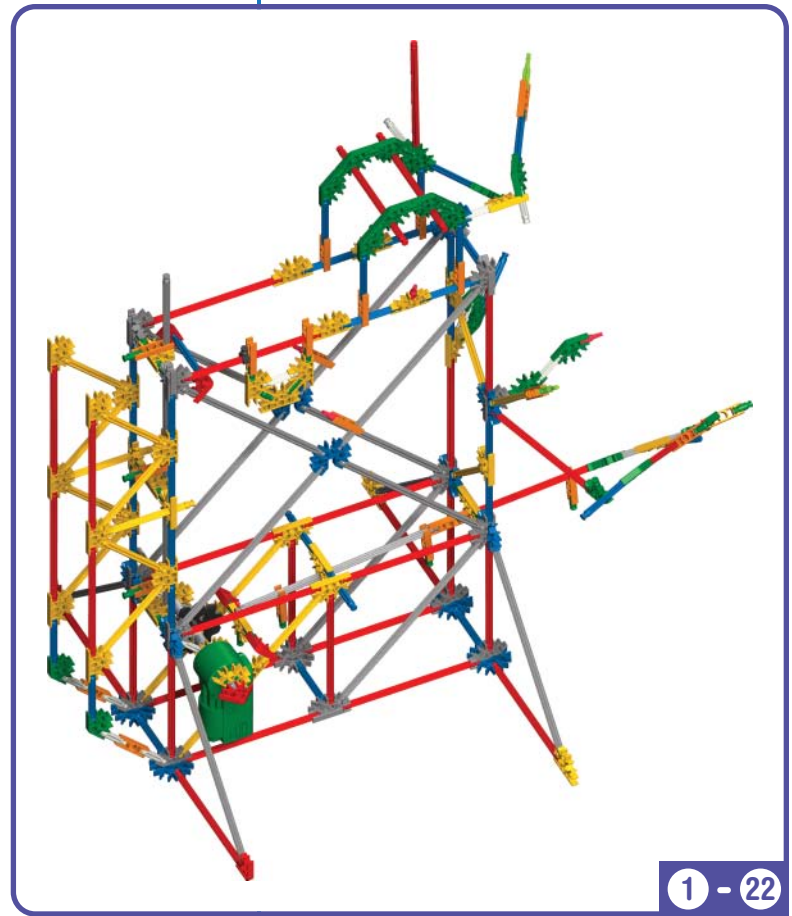
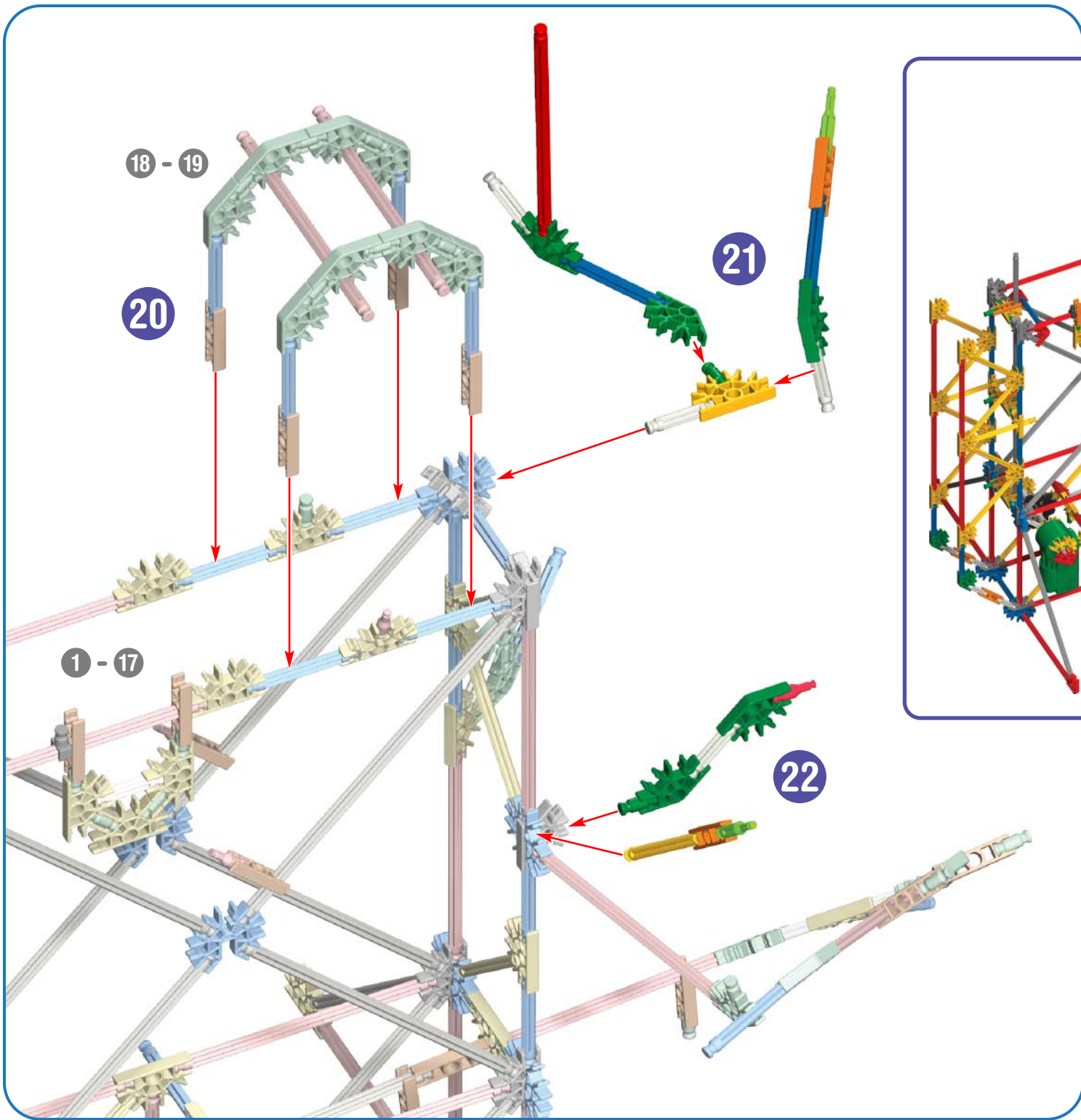

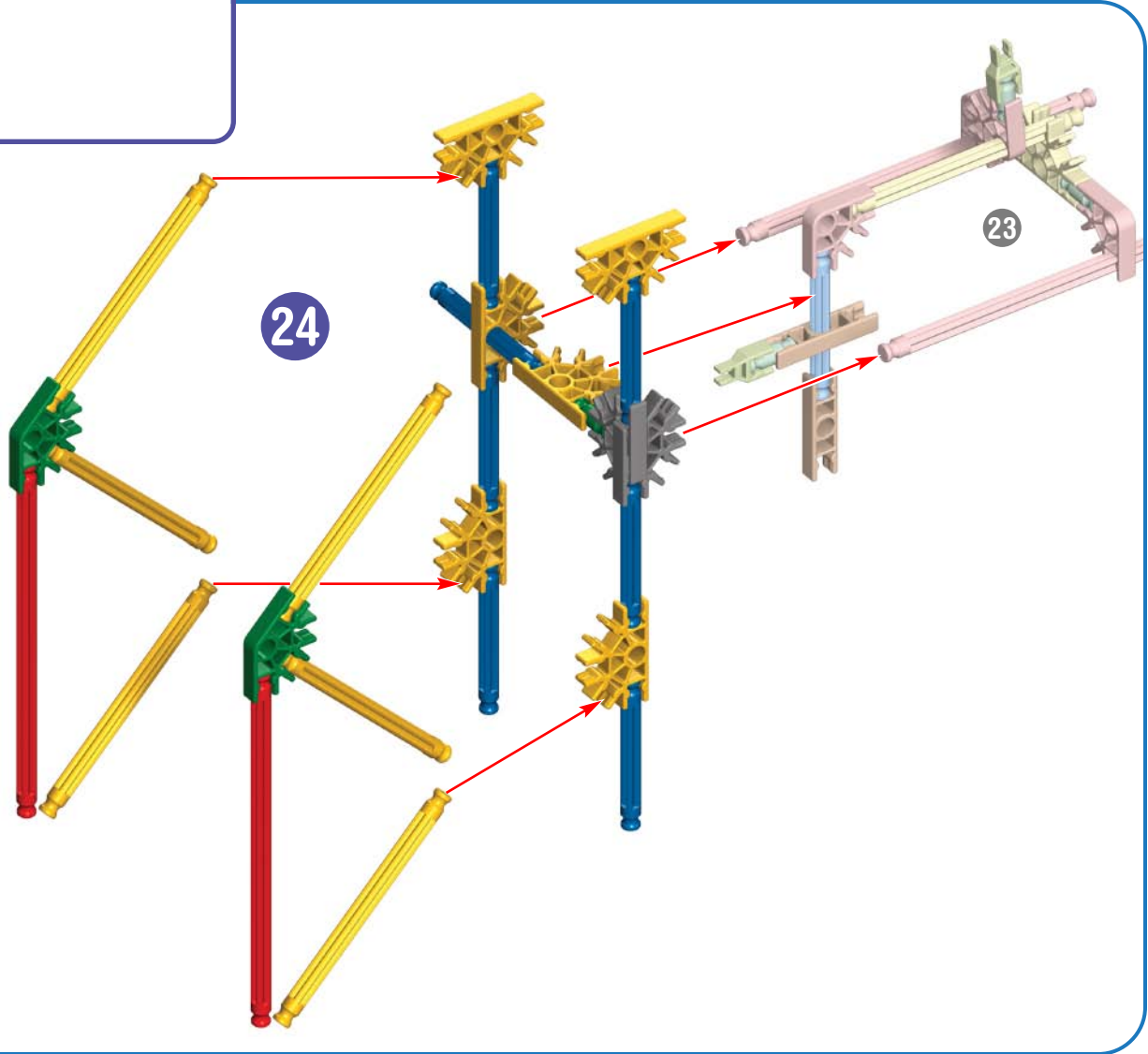
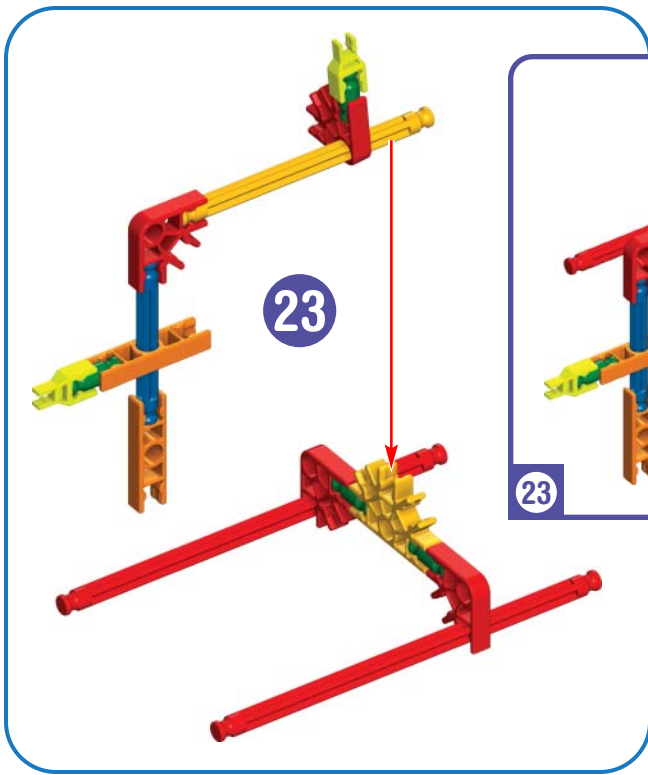

23 - 24

1 - 22

25

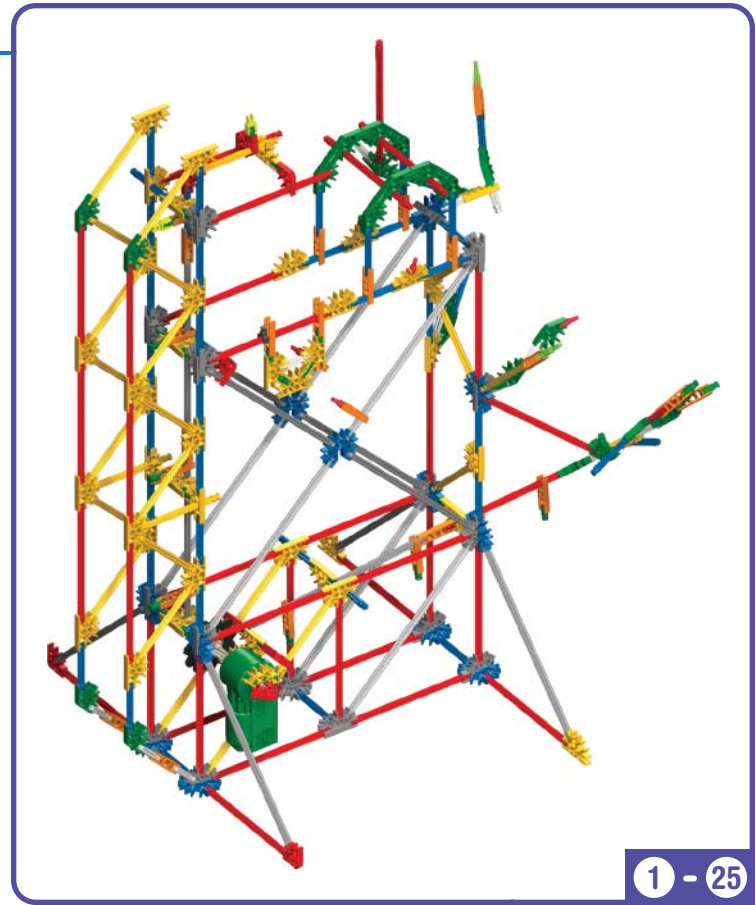
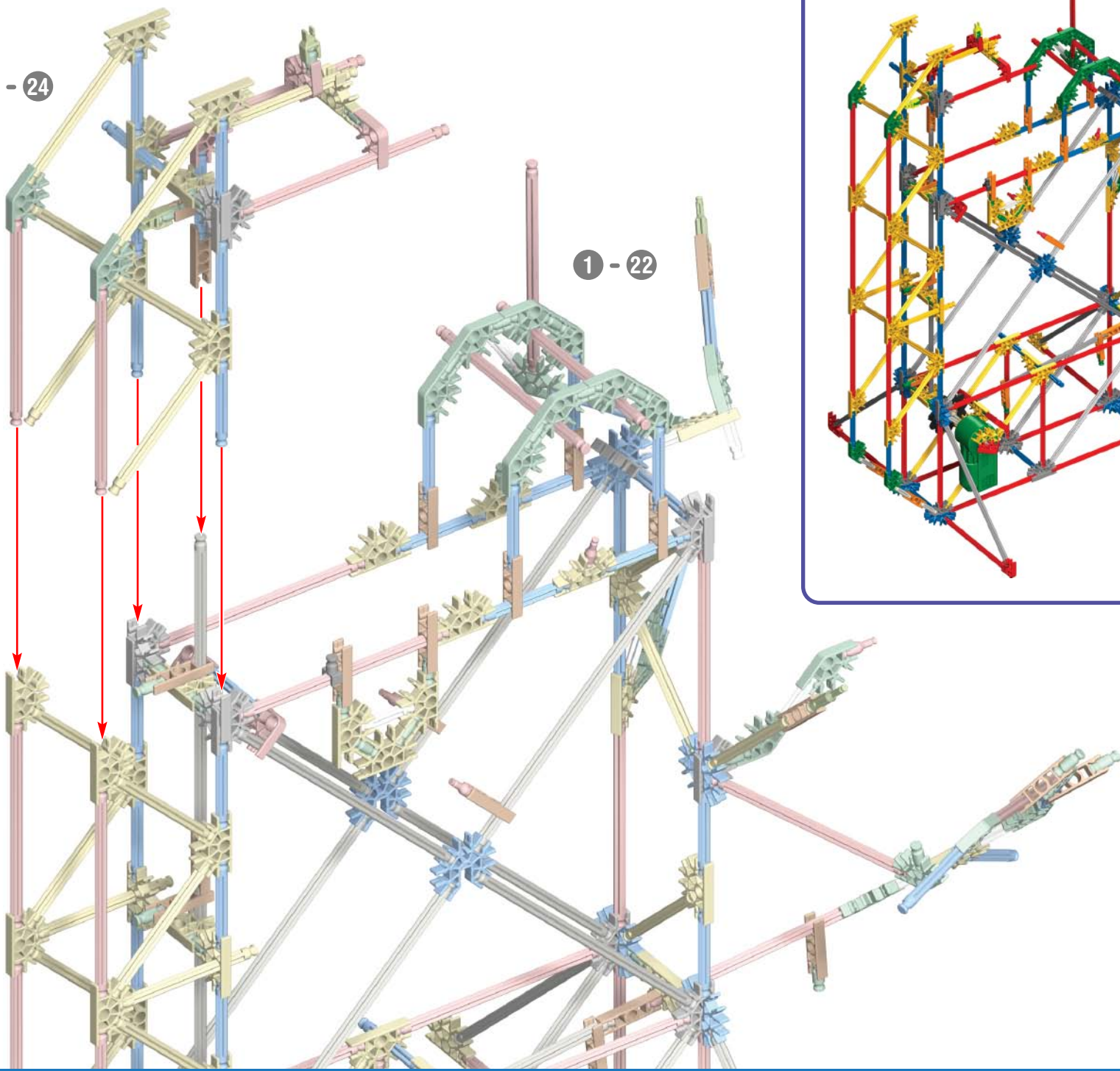

1 - 25

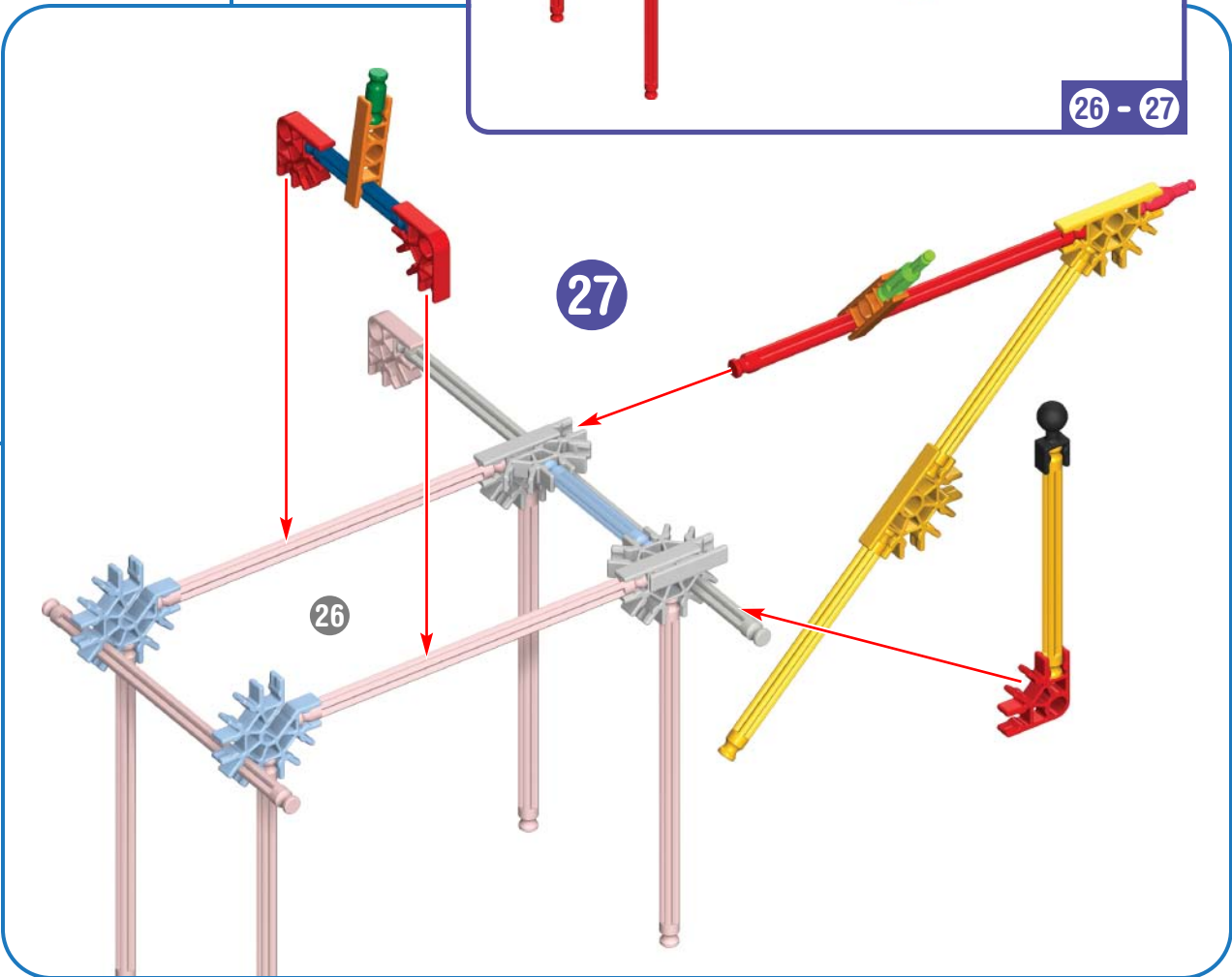
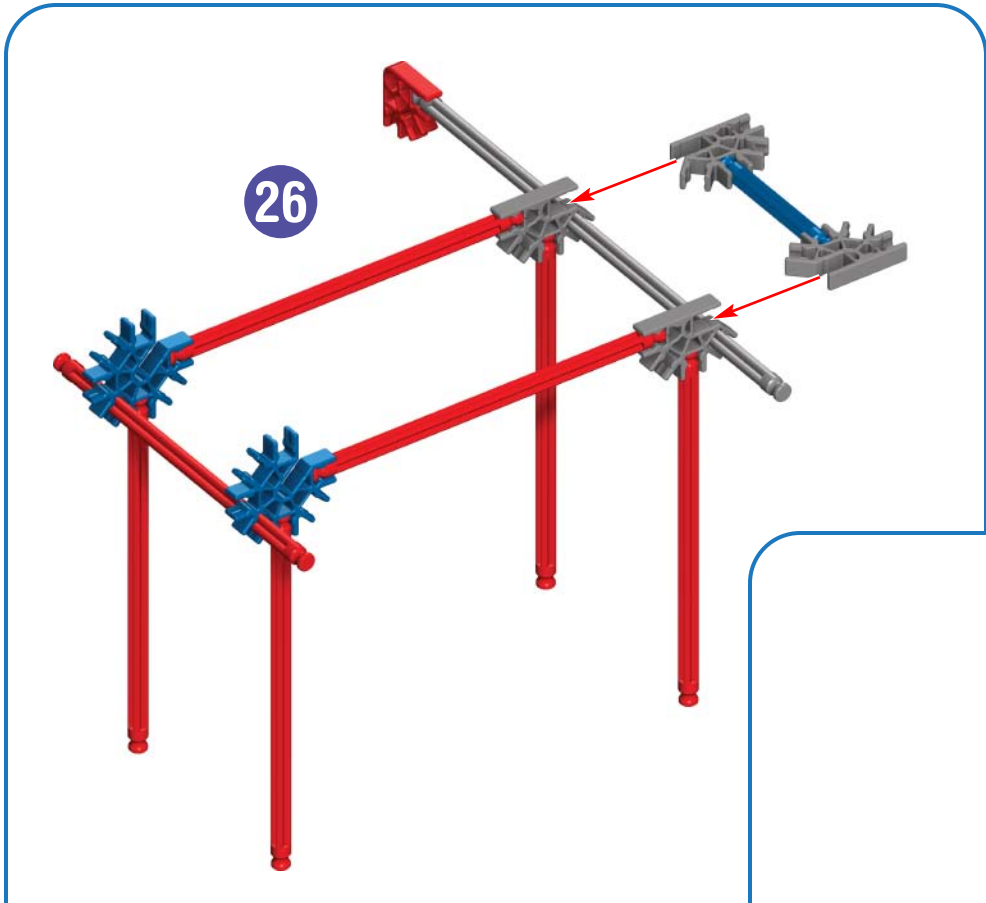

26 - 27

28

1 - 25

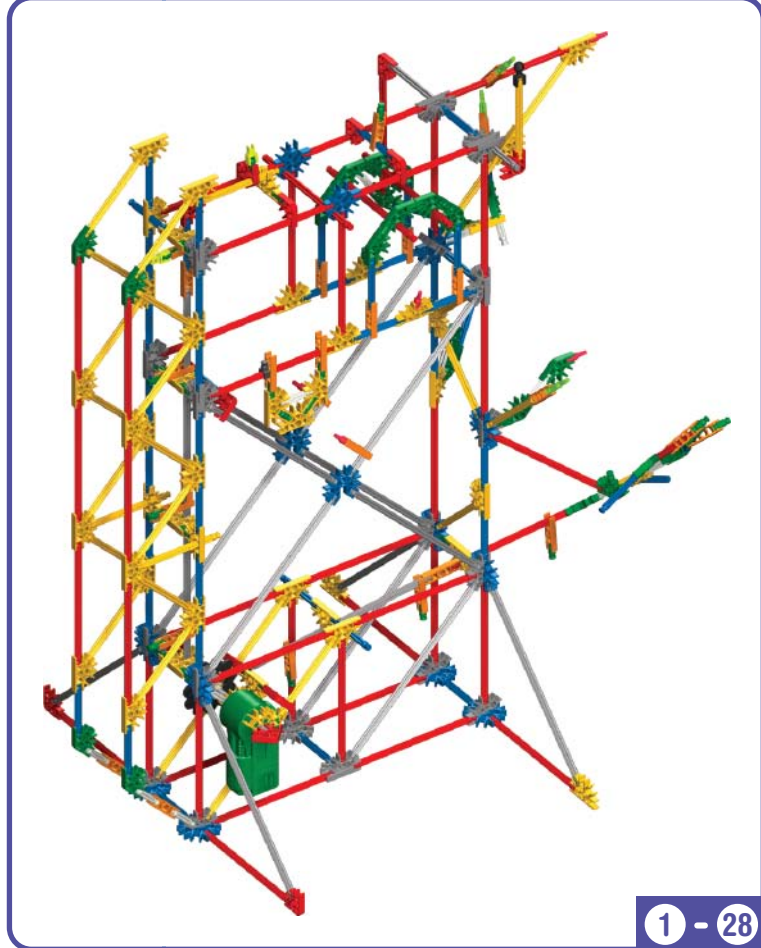
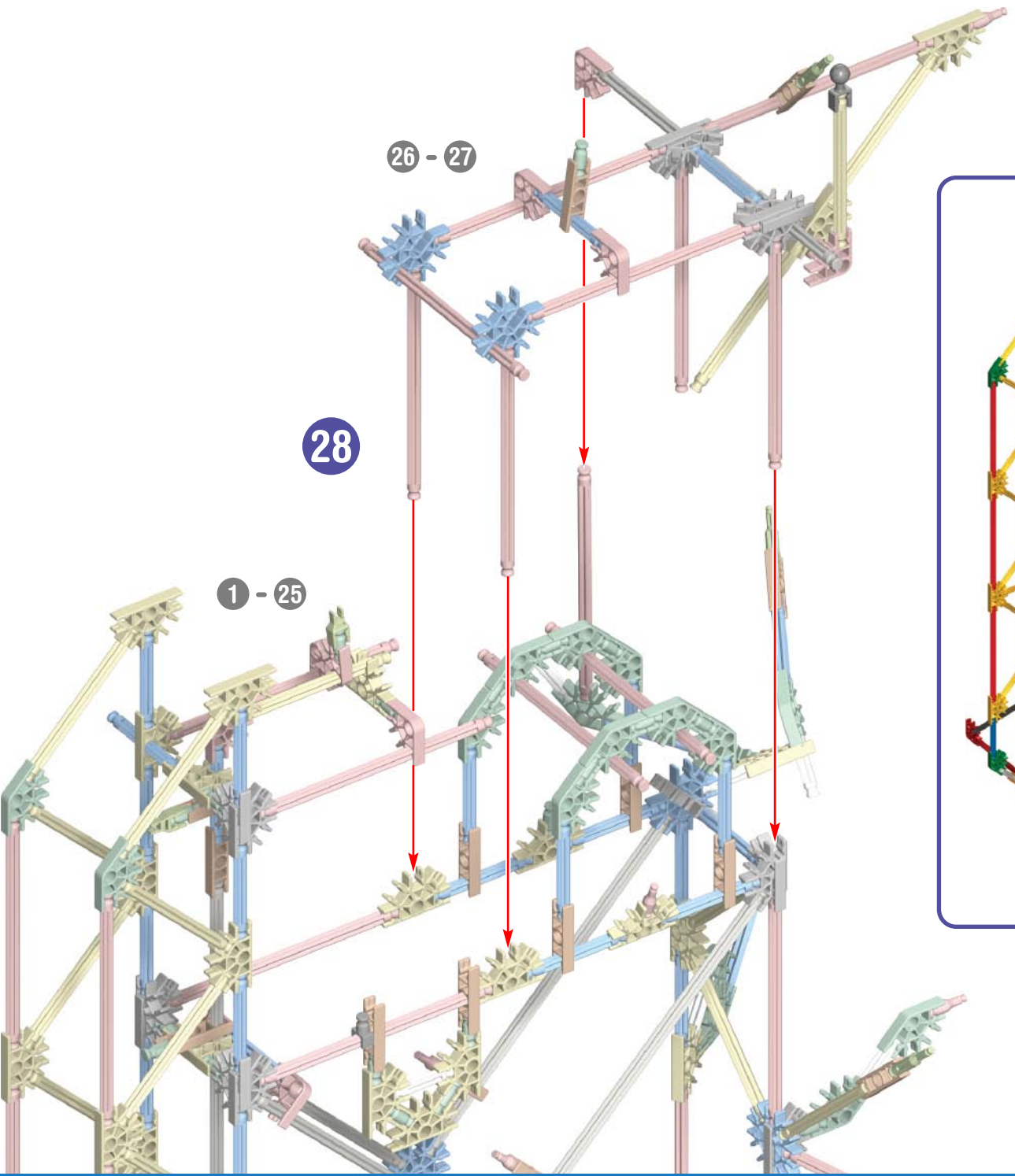

1 - 28

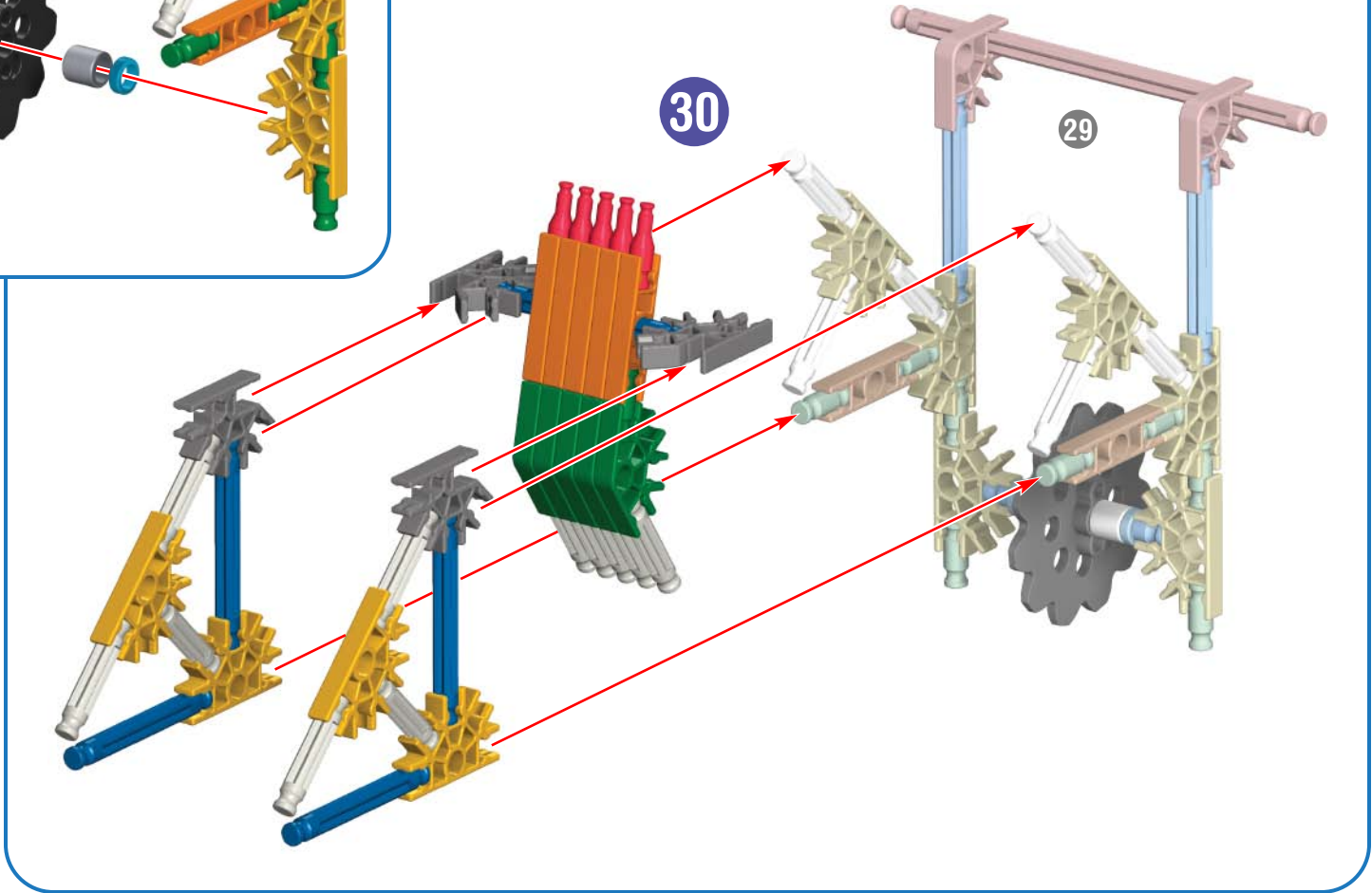
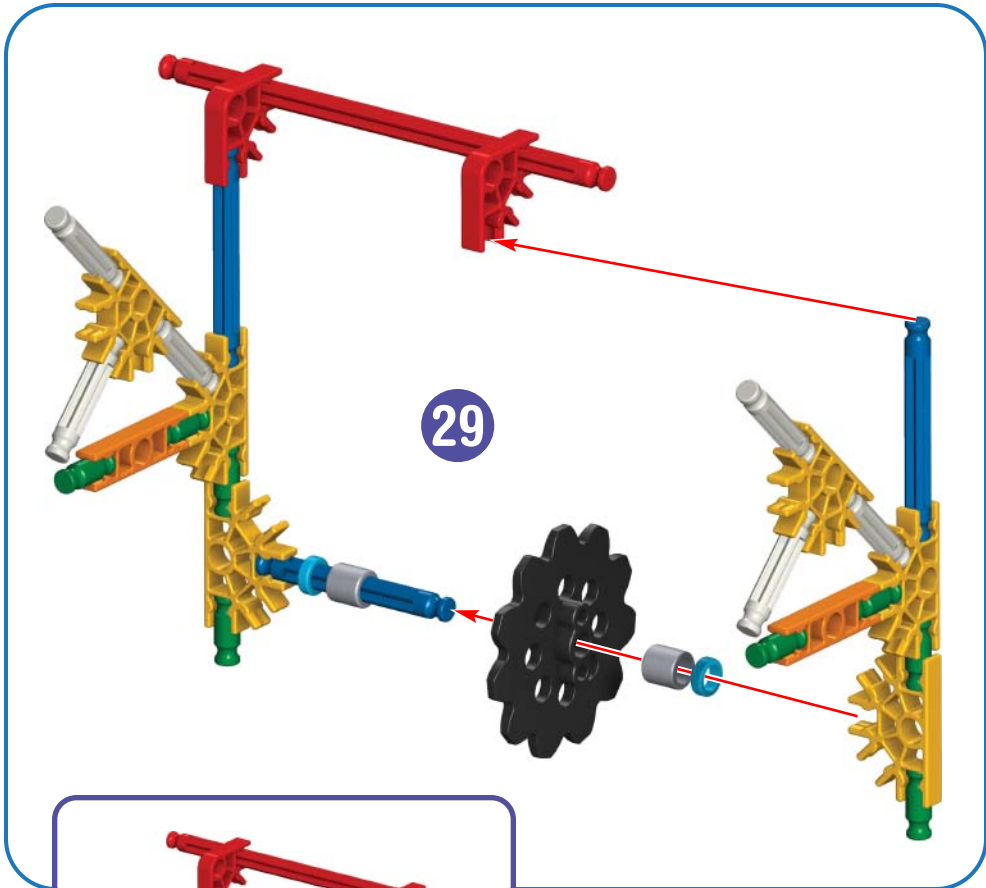

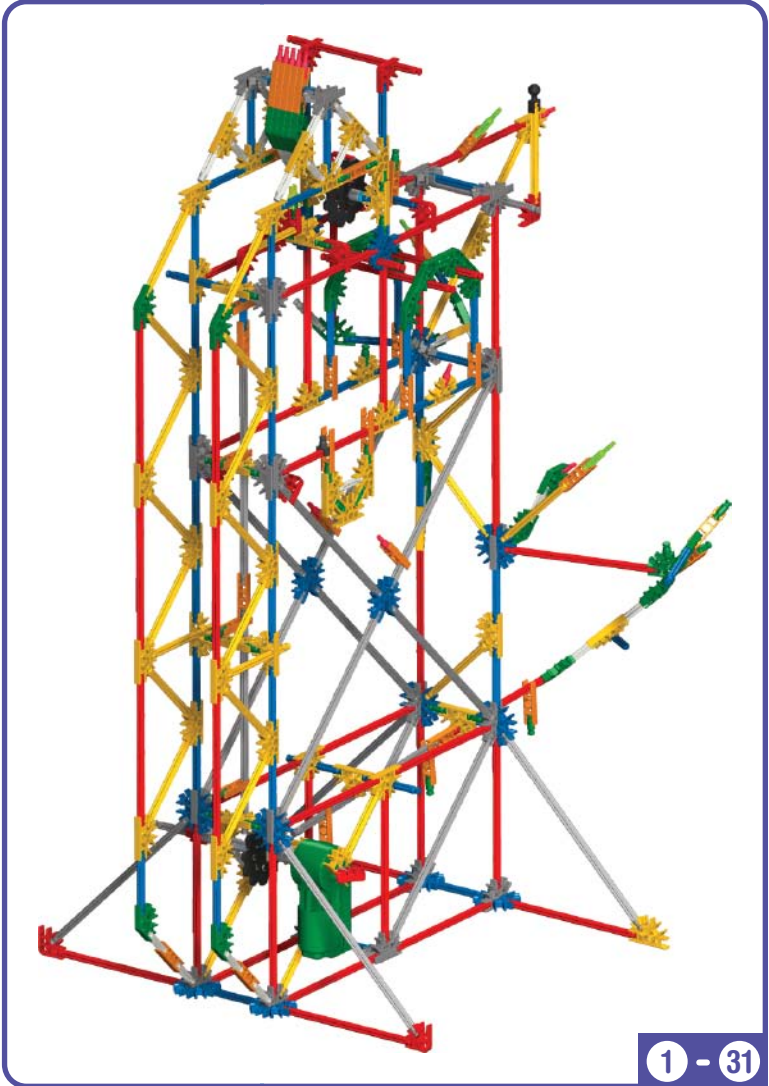
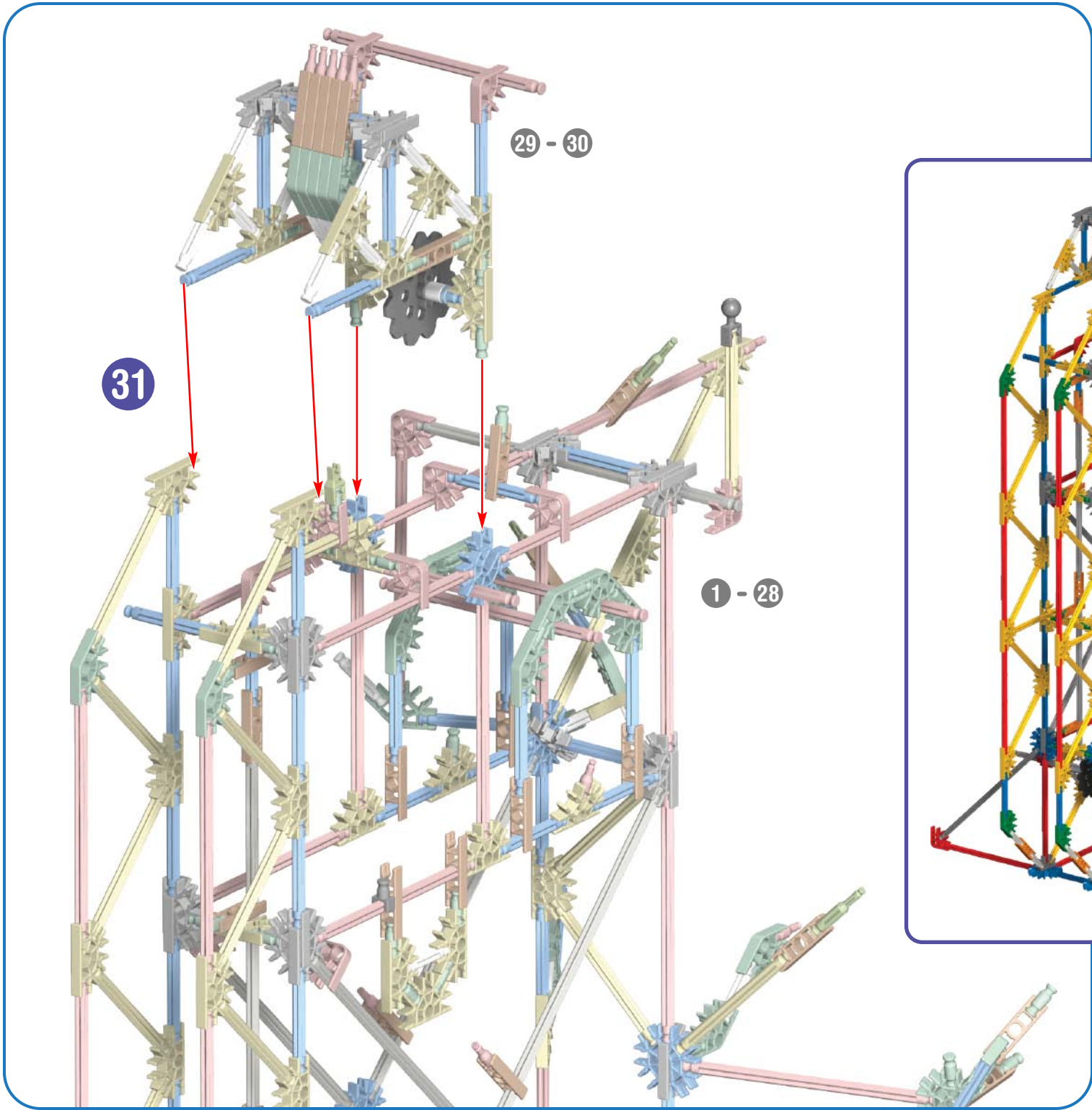

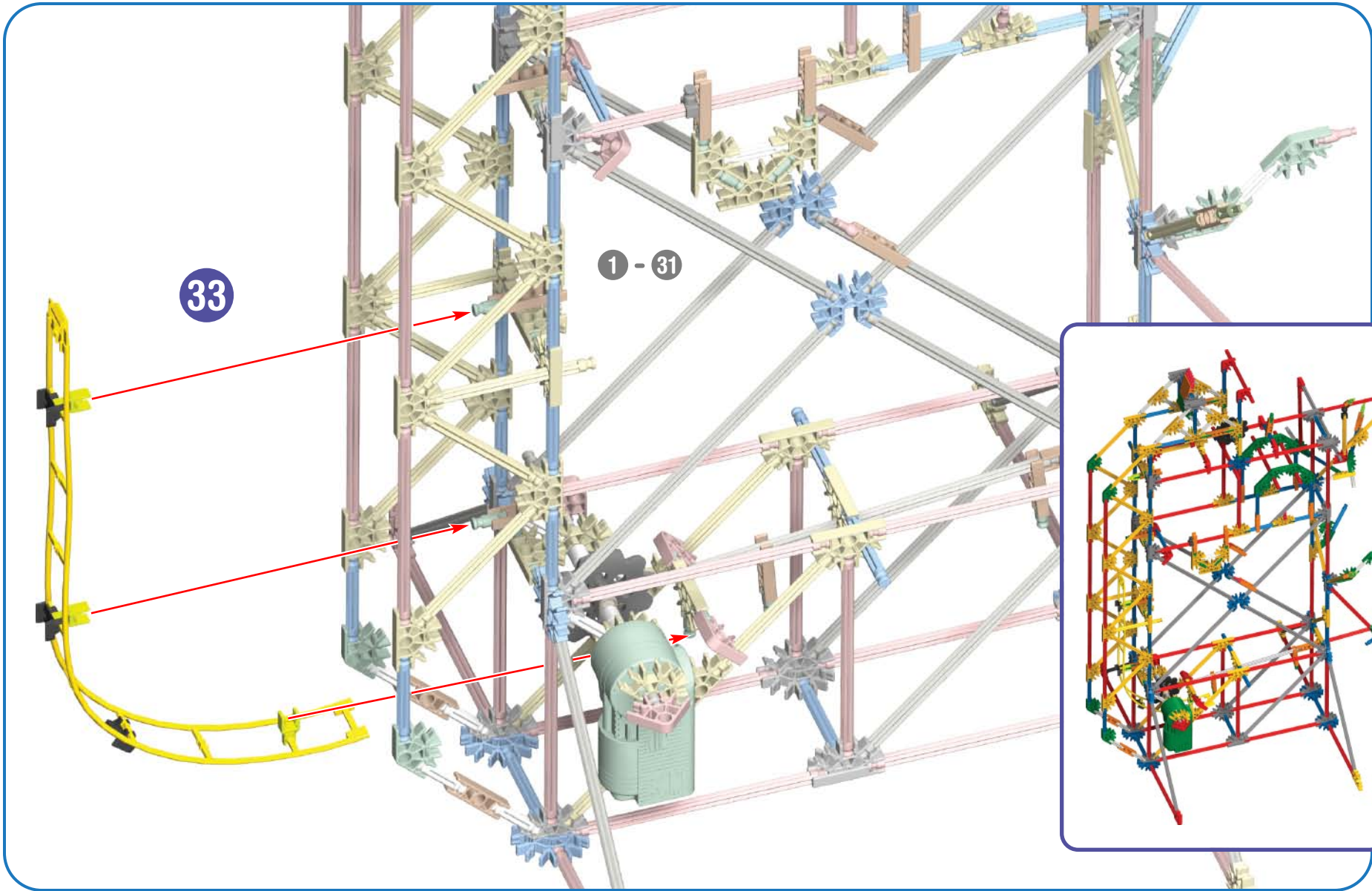
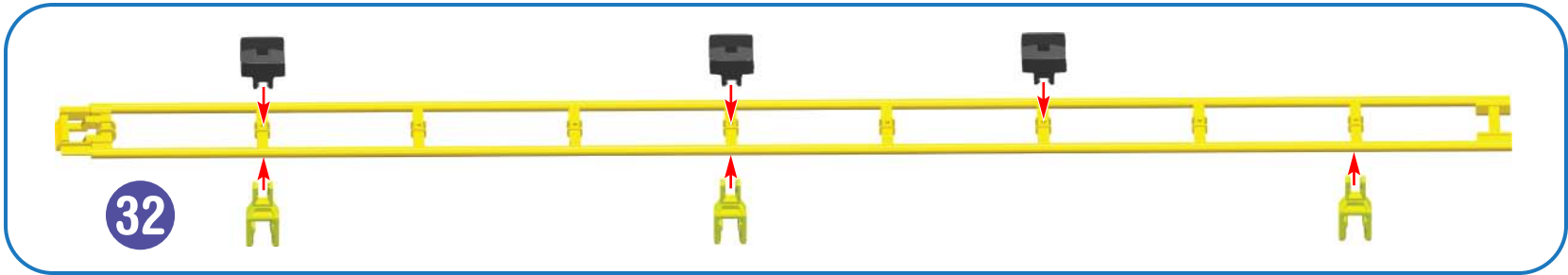

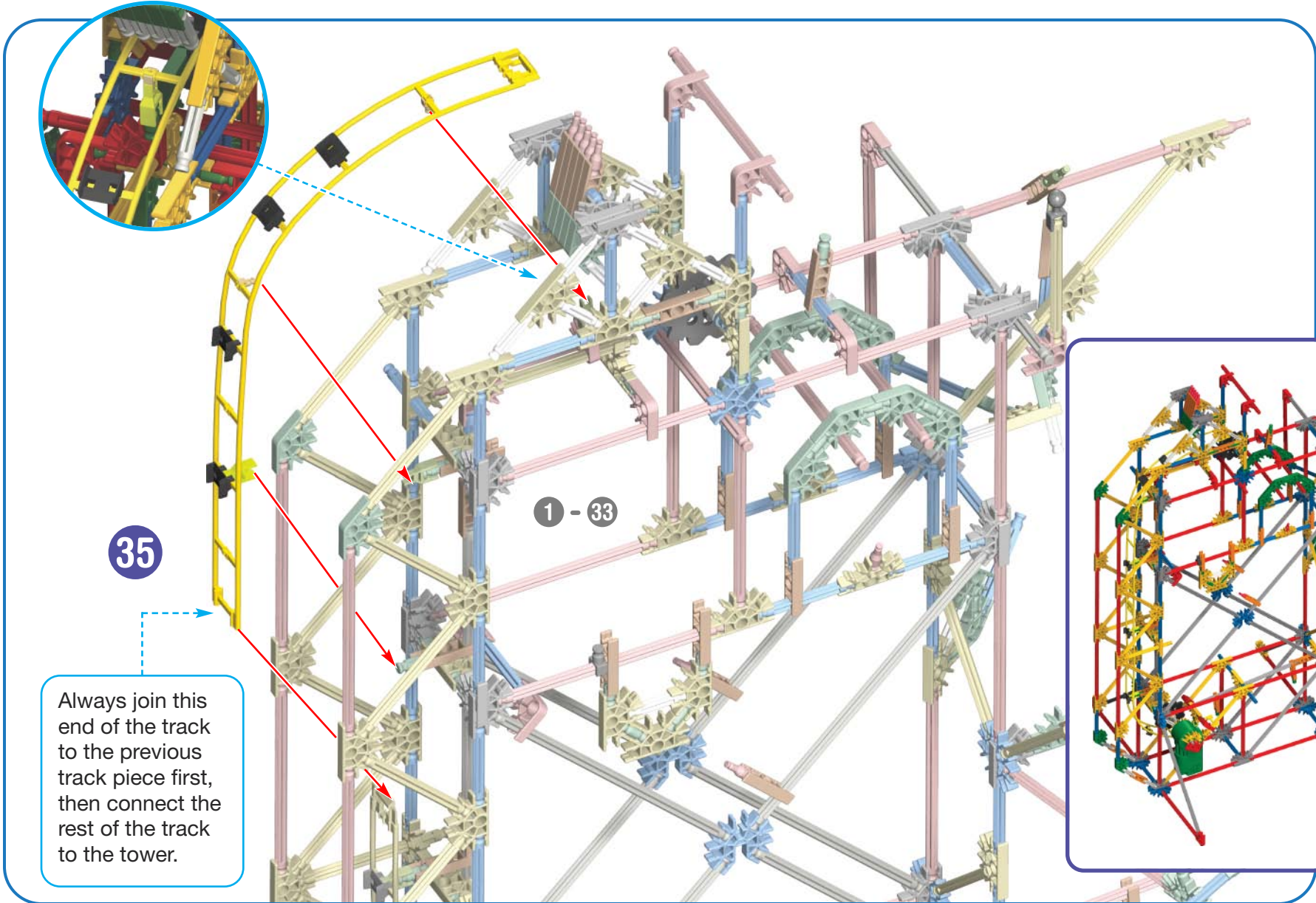
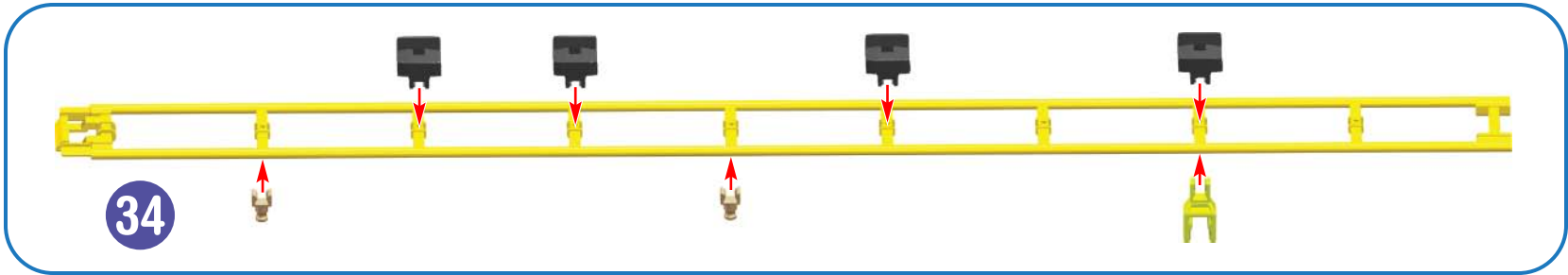

Always join this end of the track to the previous track piece first, then connect the rest of the track to the tower.

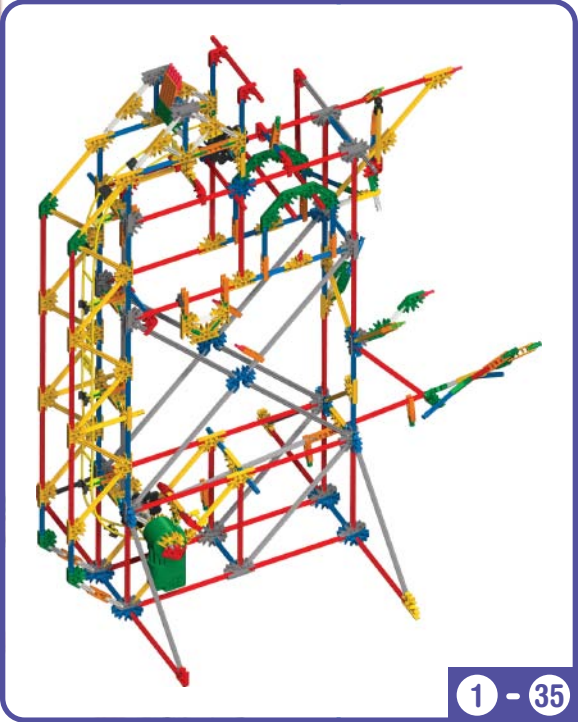

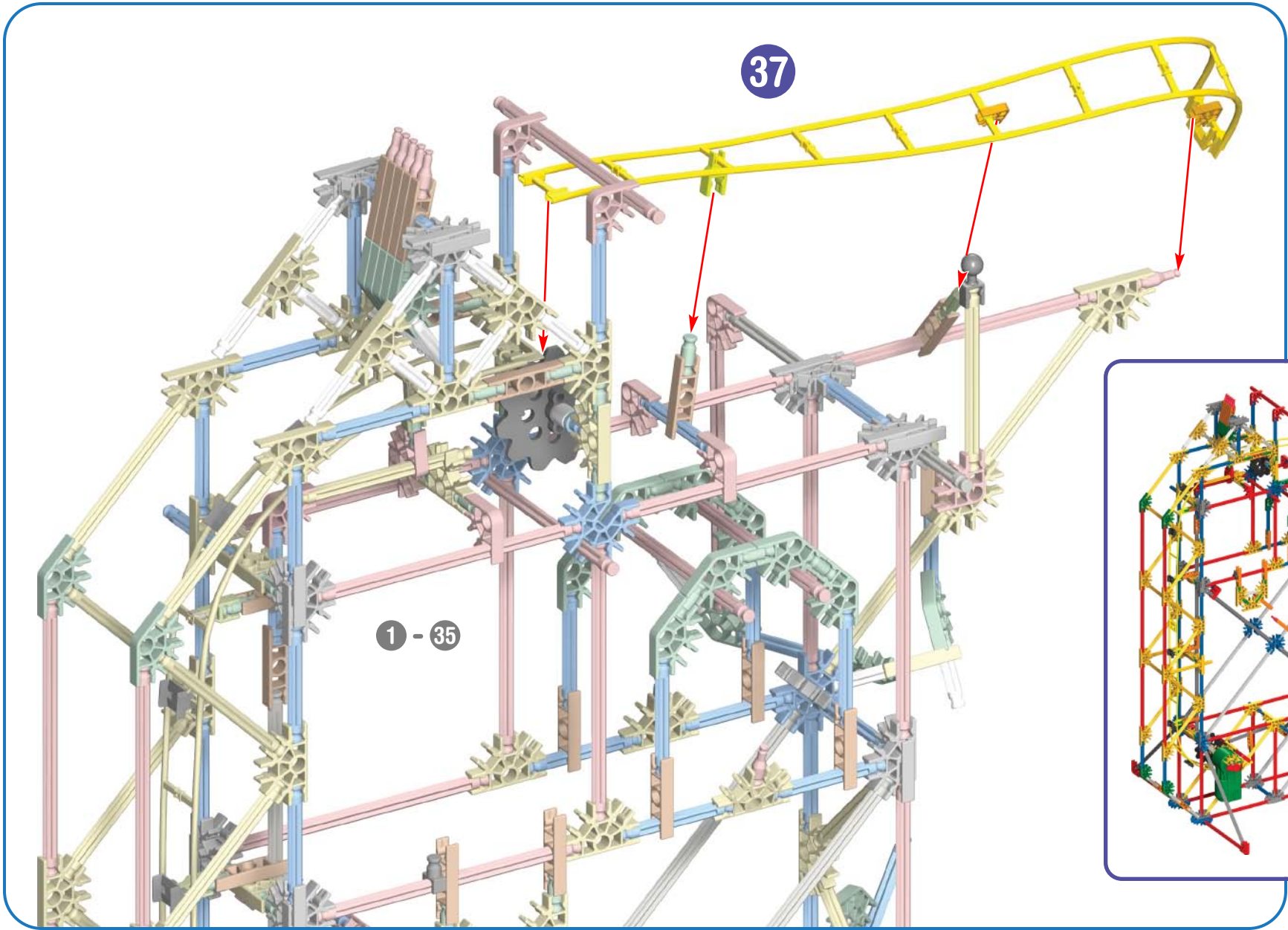
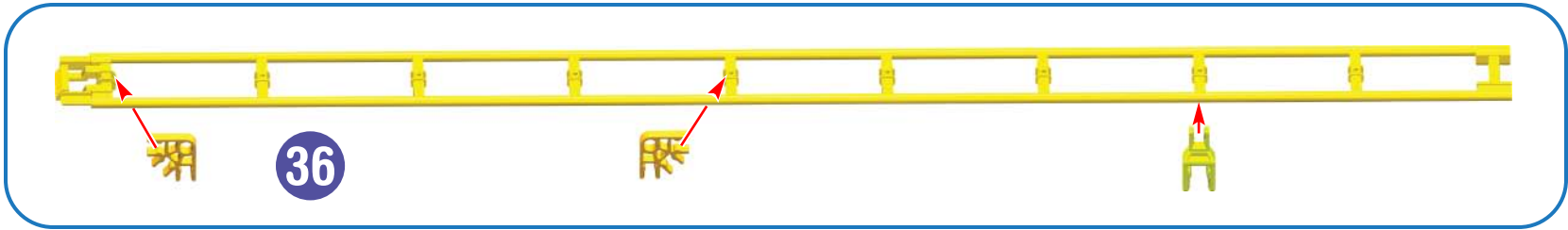

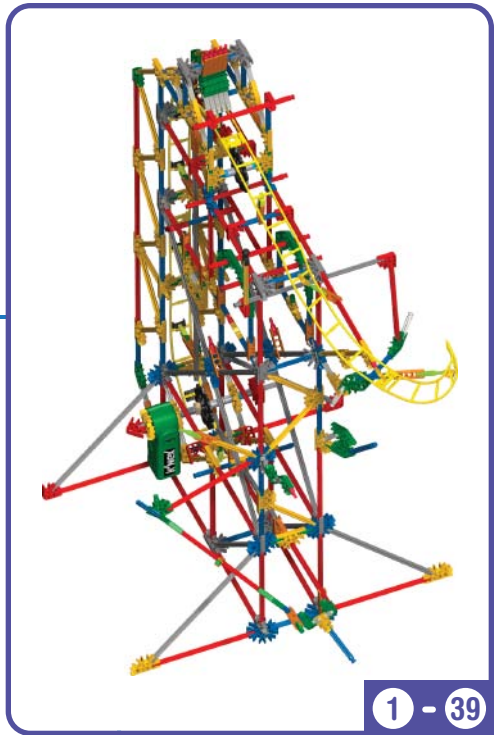
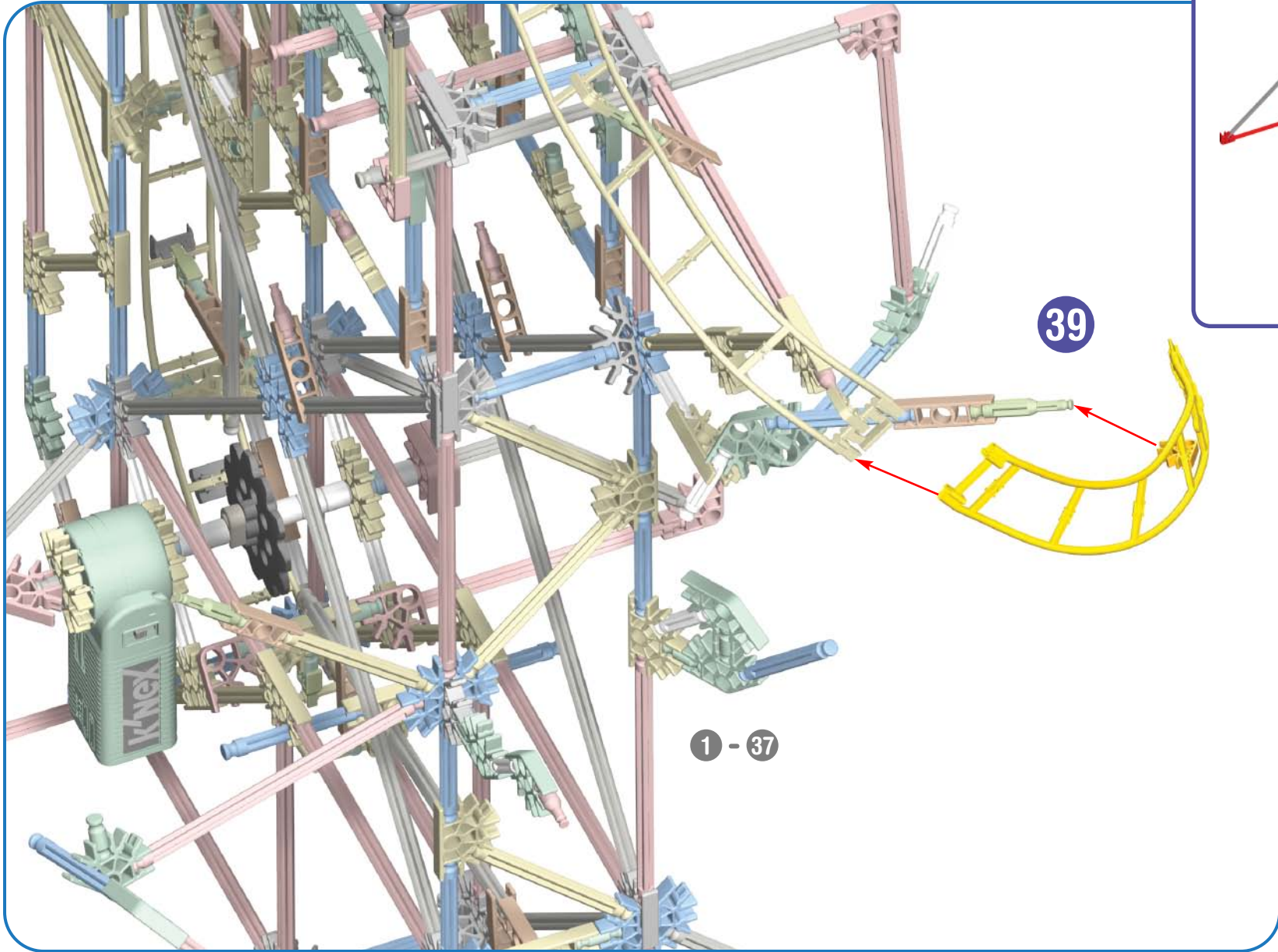
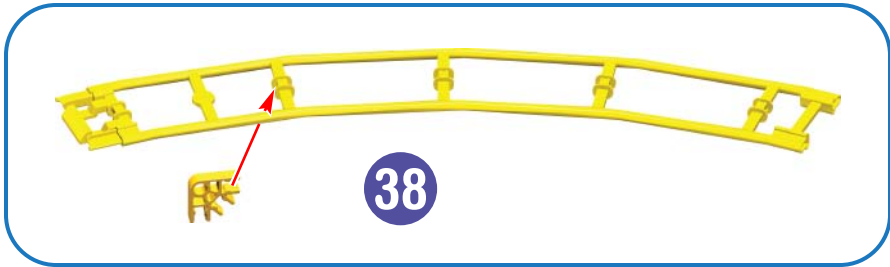

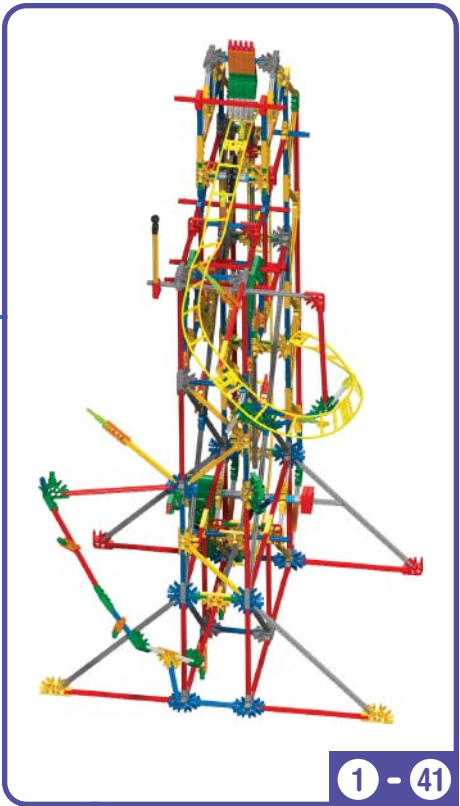
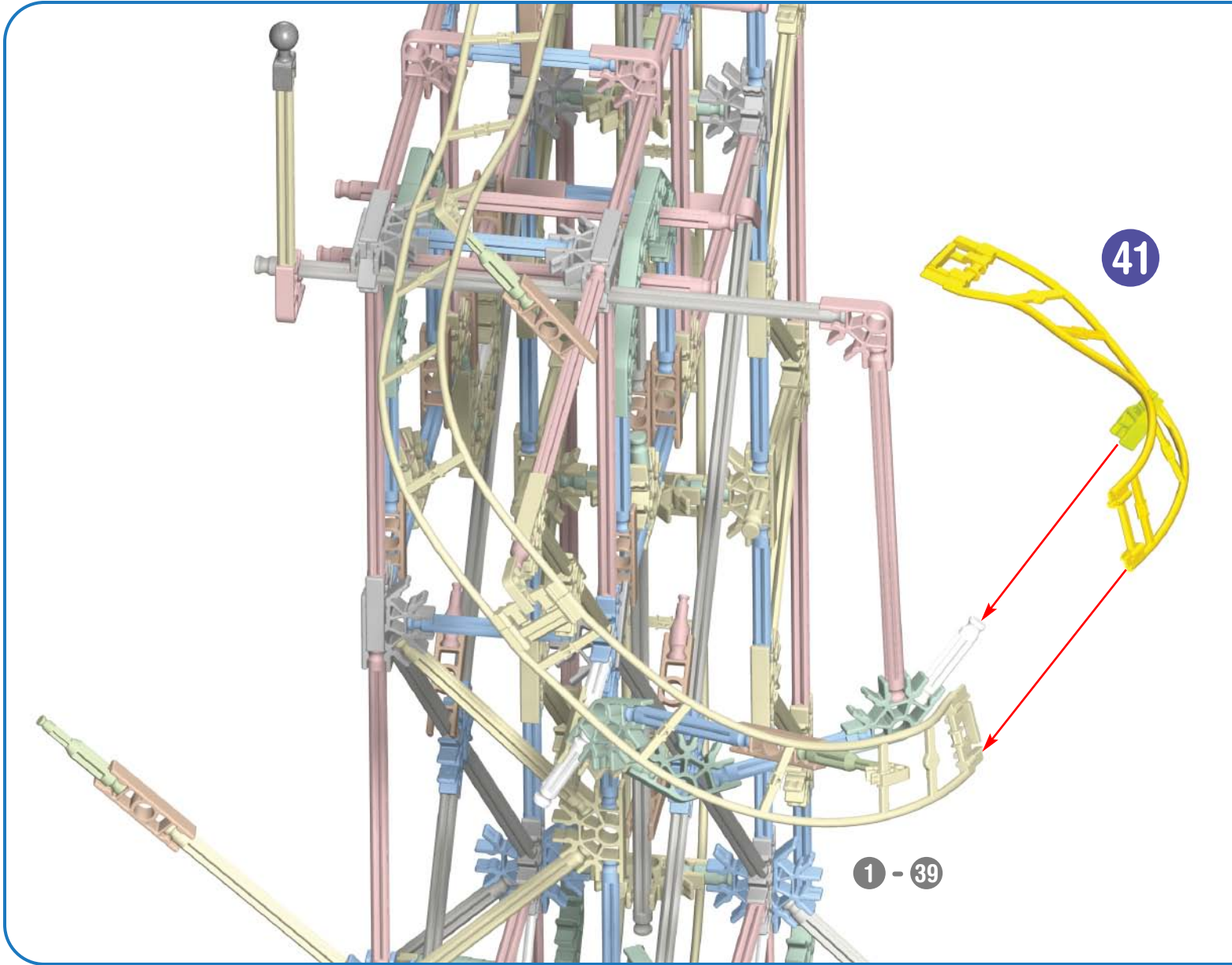
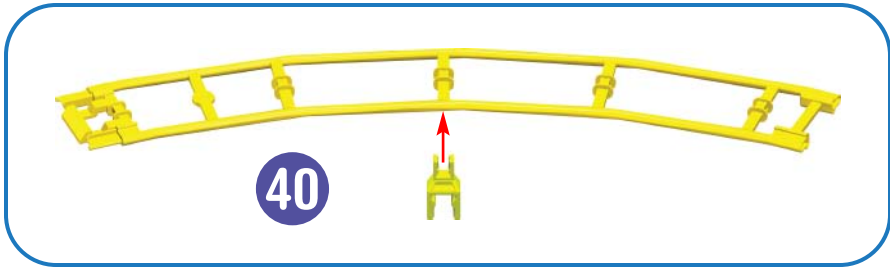

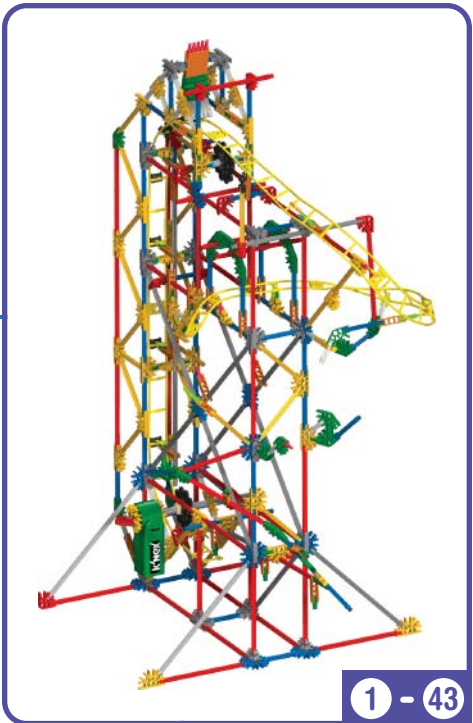
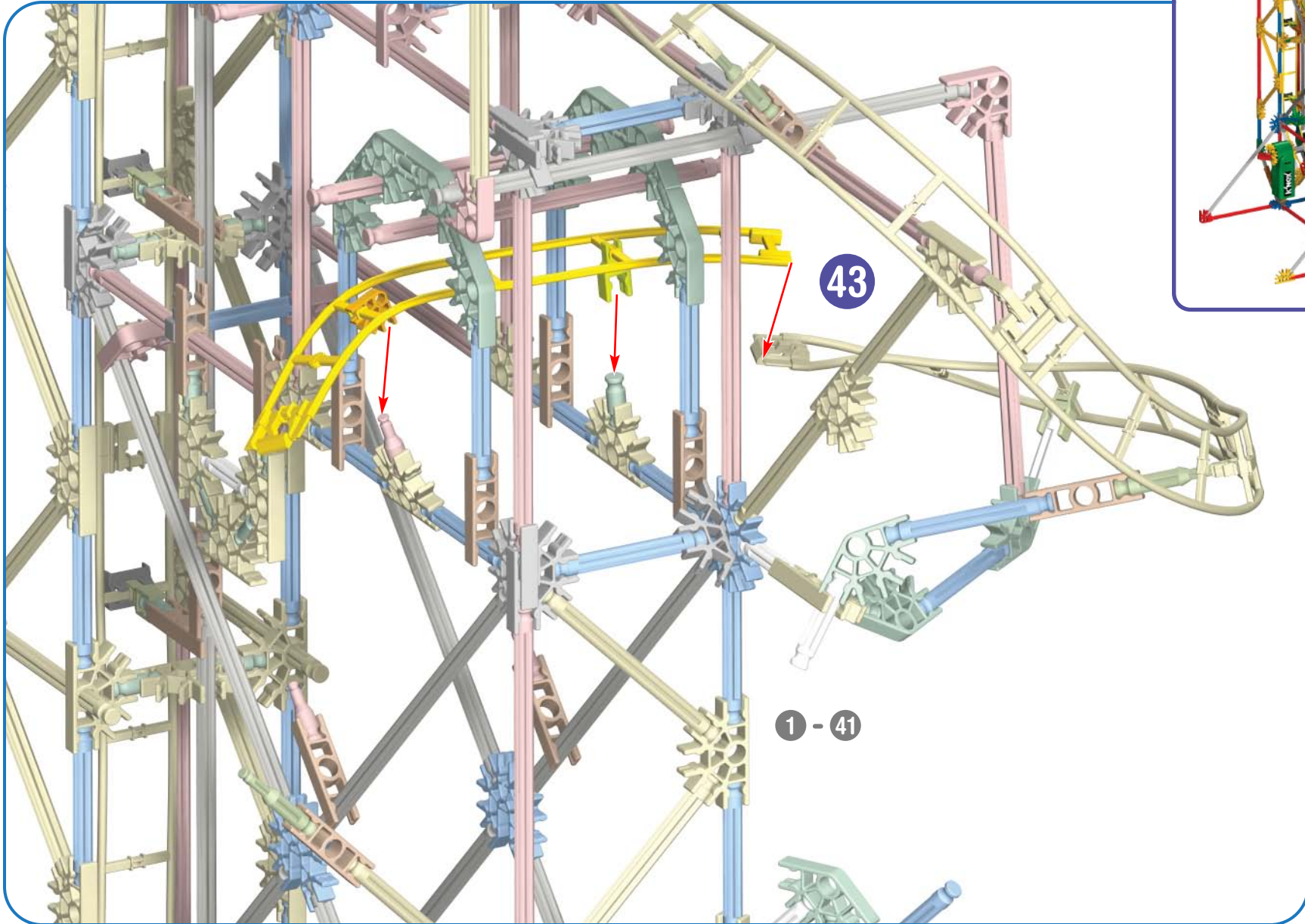
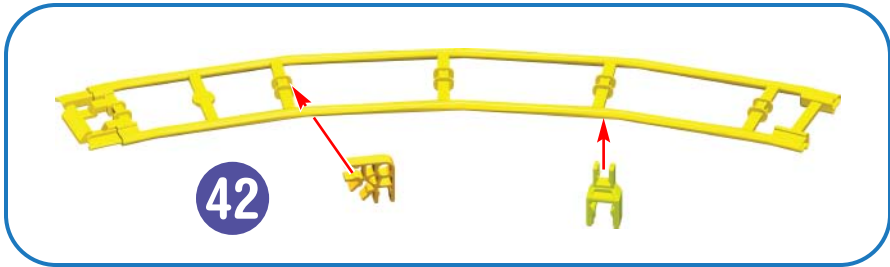

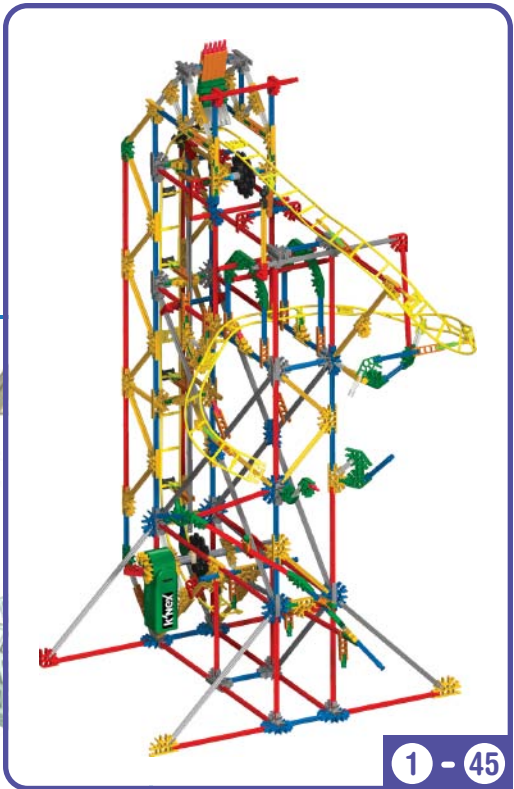
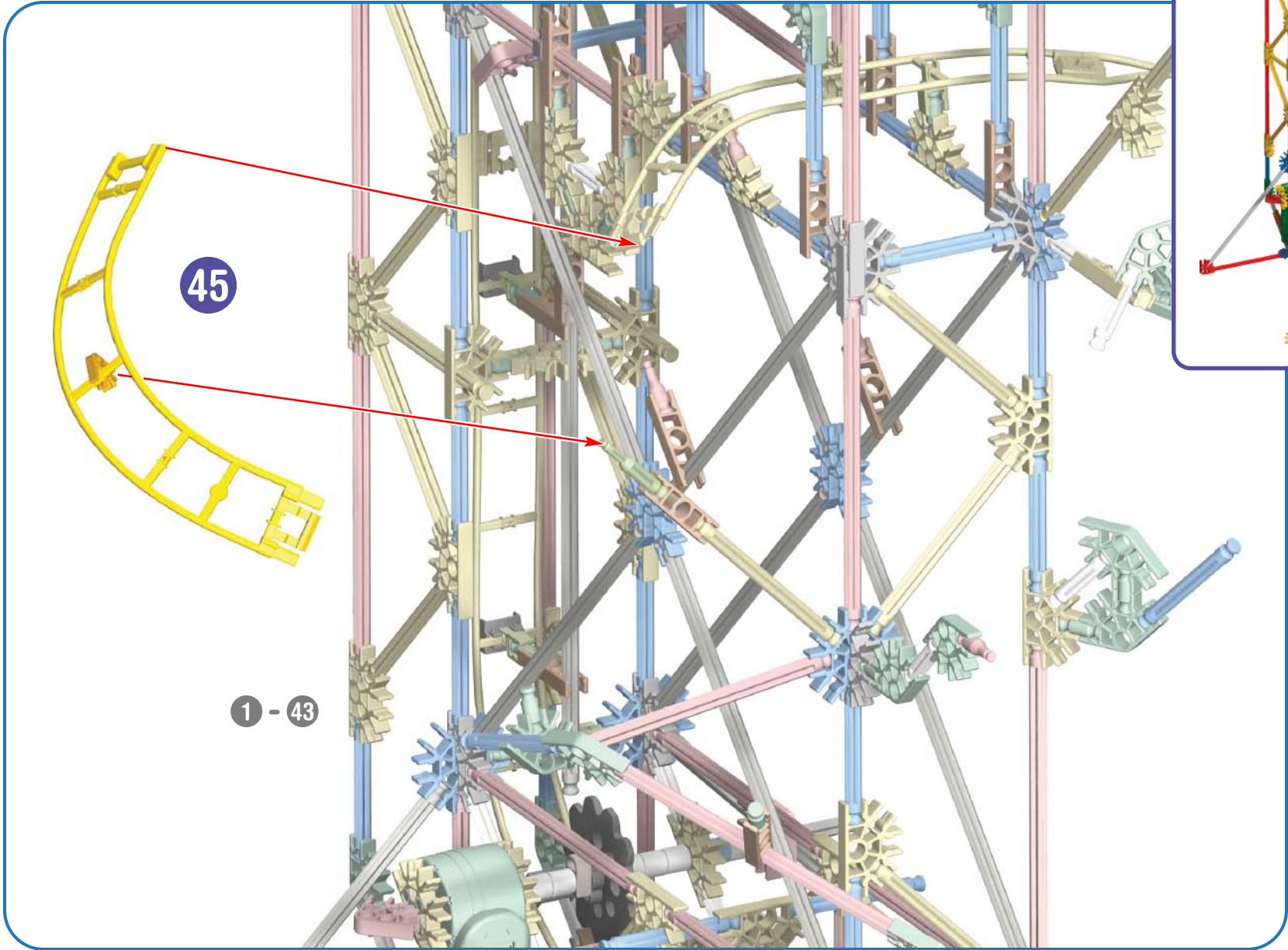
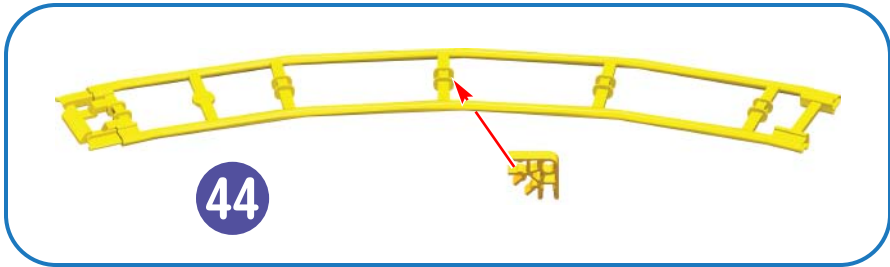

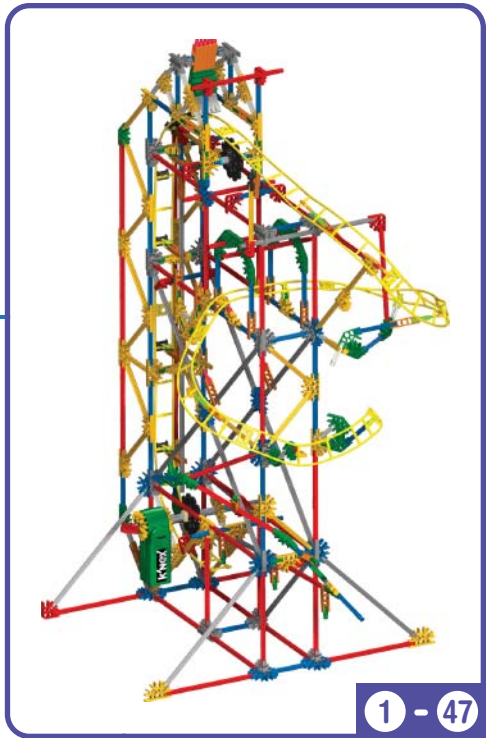
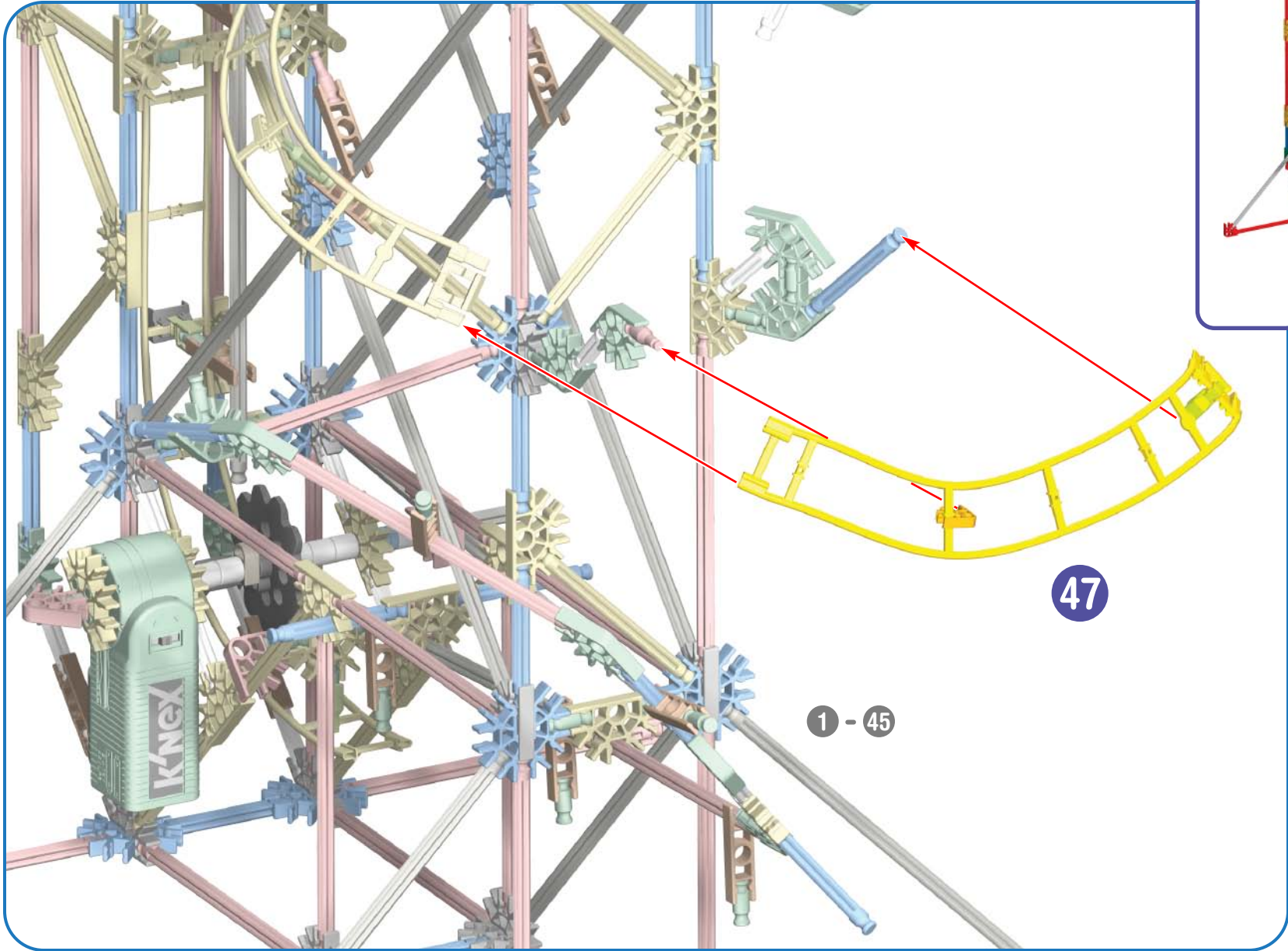
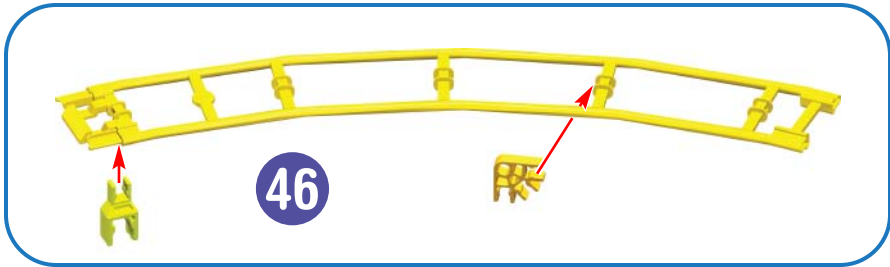



48

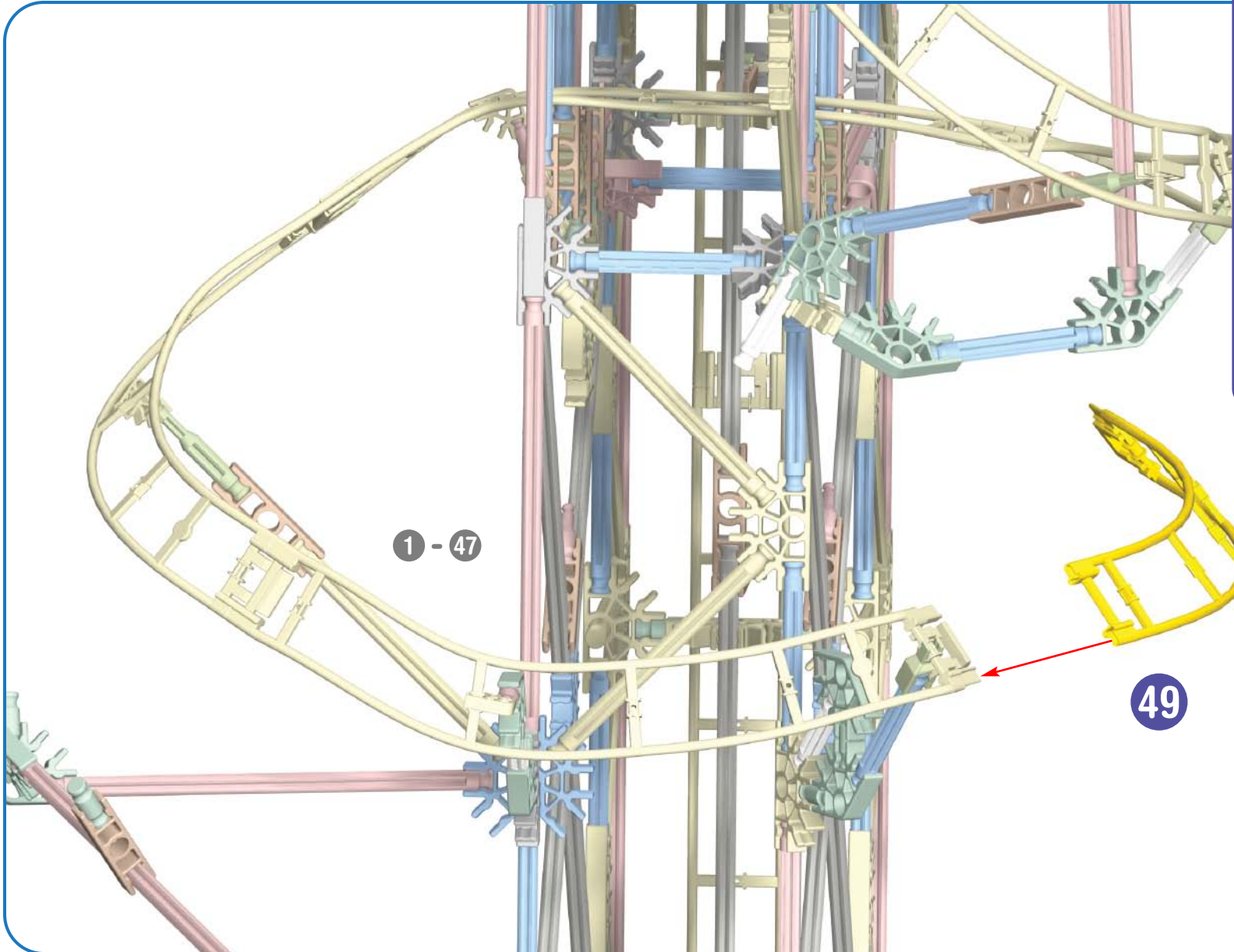

1 - 47

49

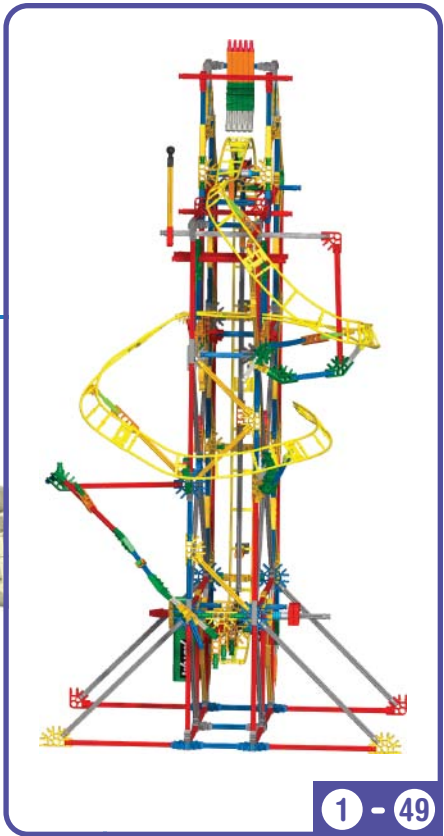

1 - 49

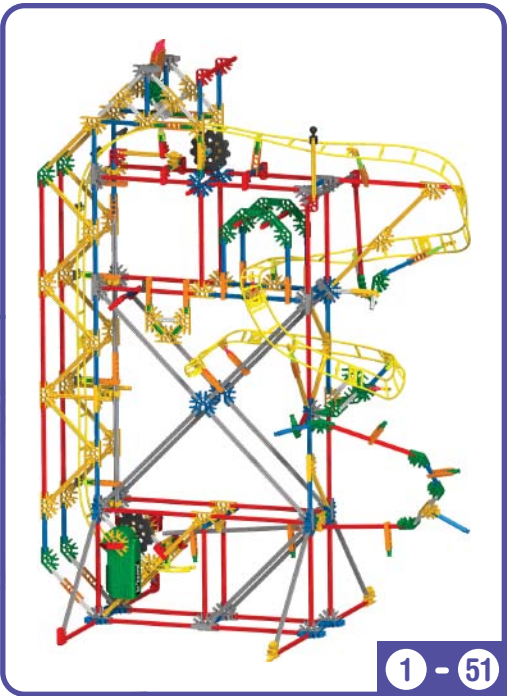
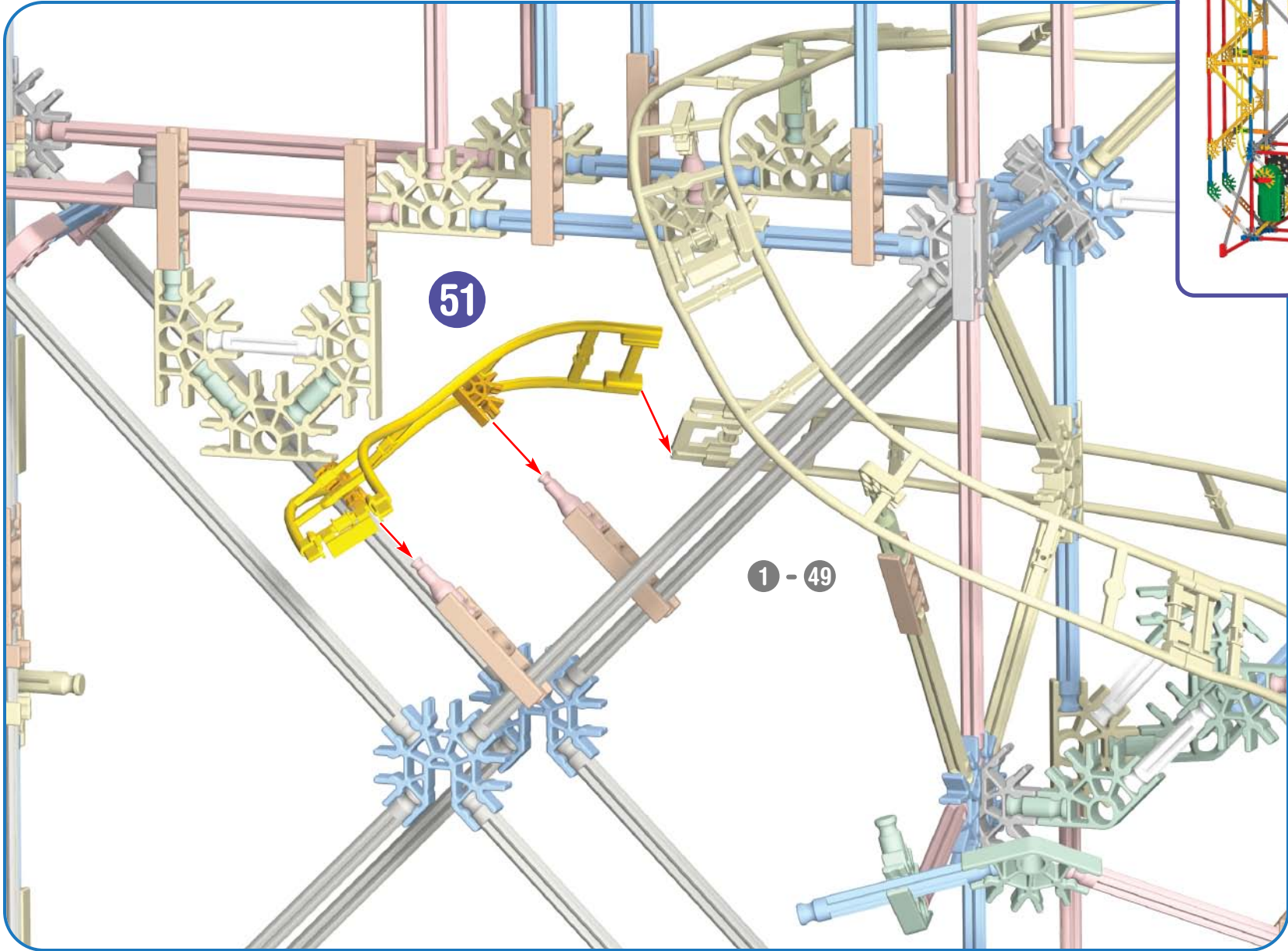
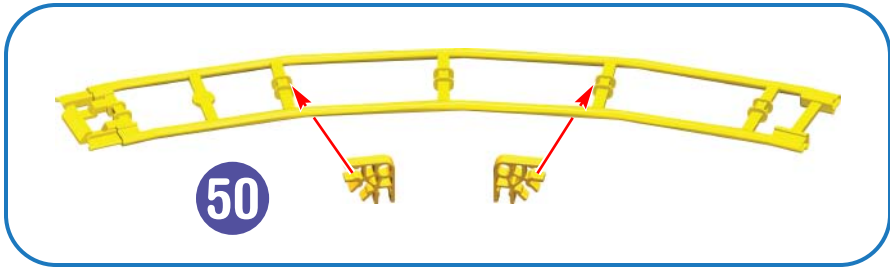

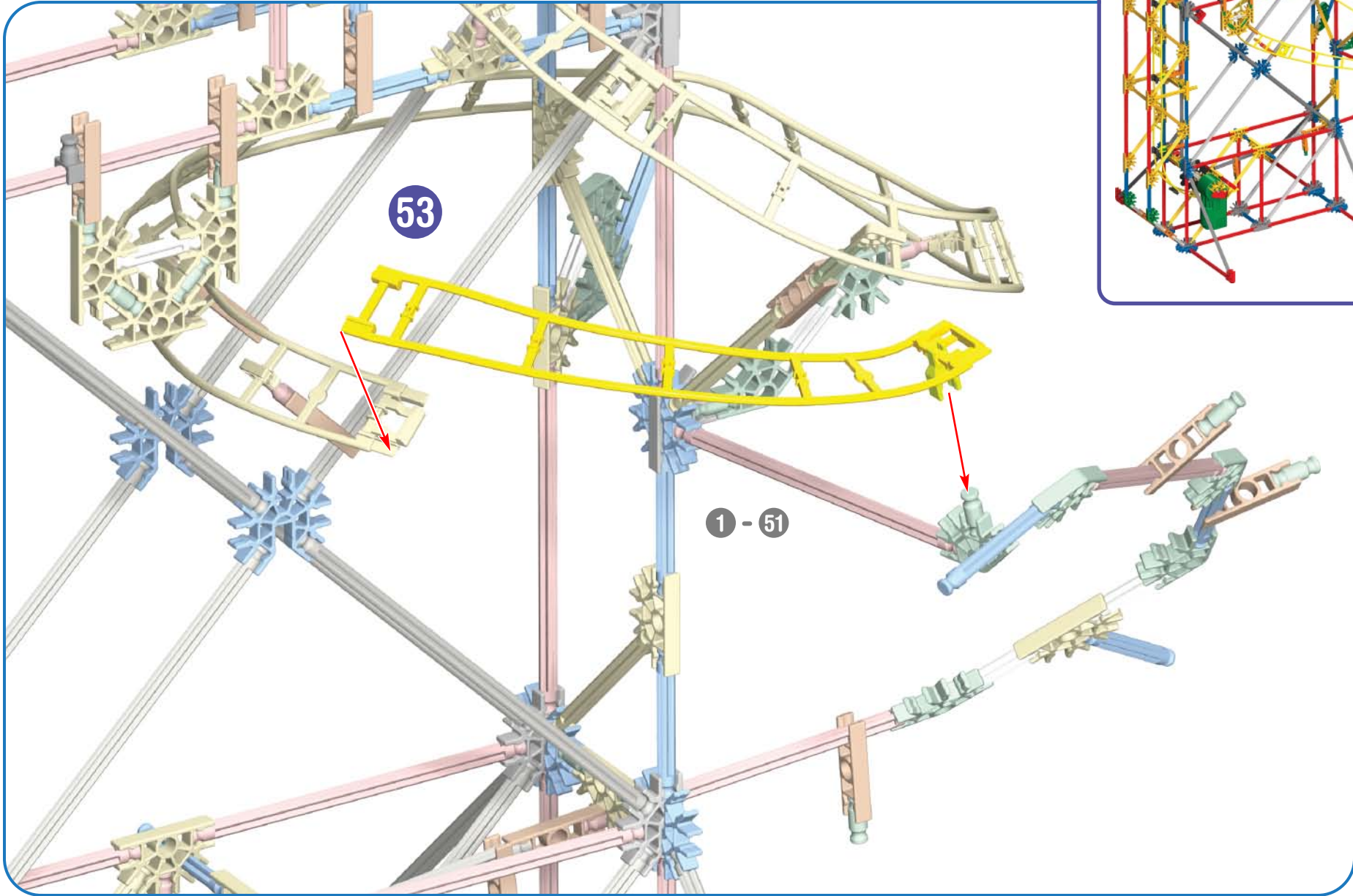
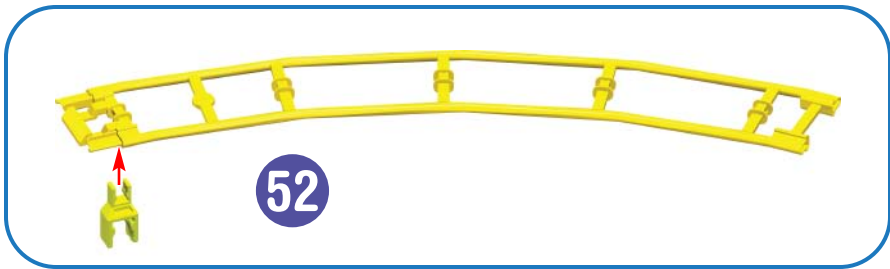

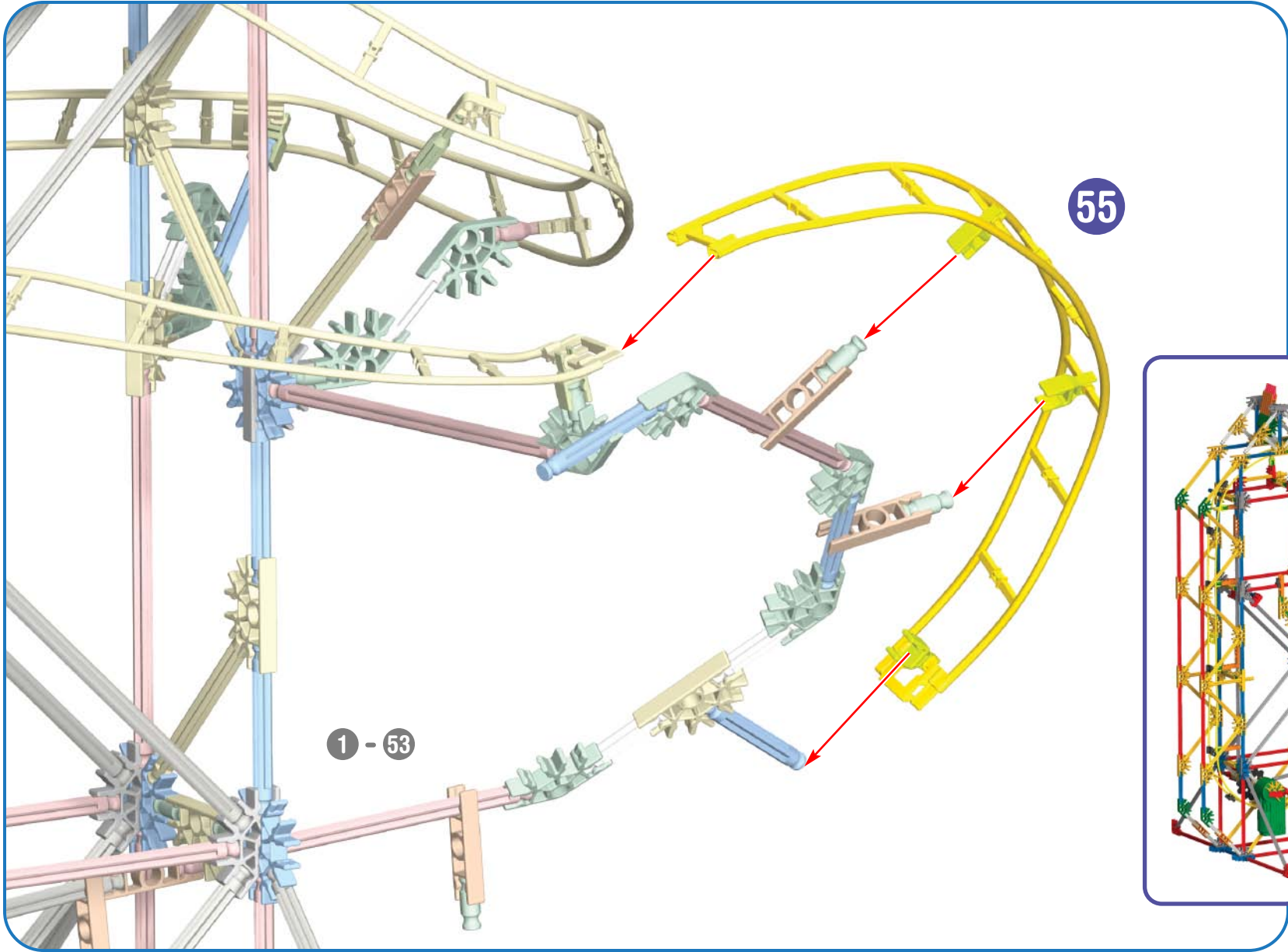
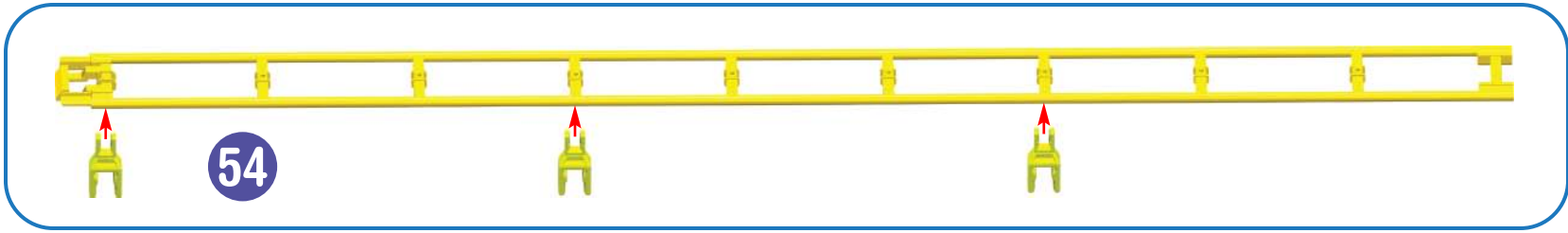



56

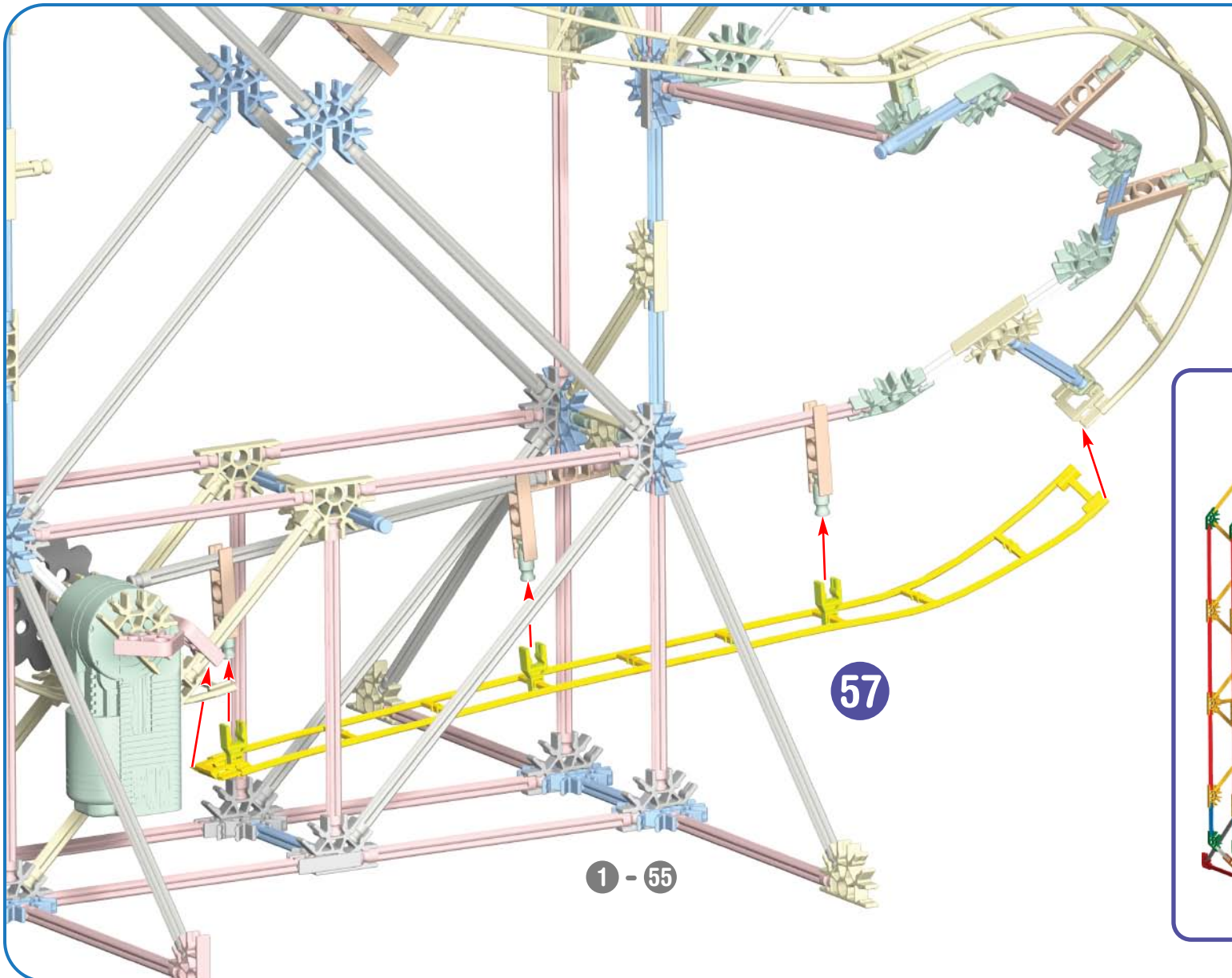

57

1 - 55

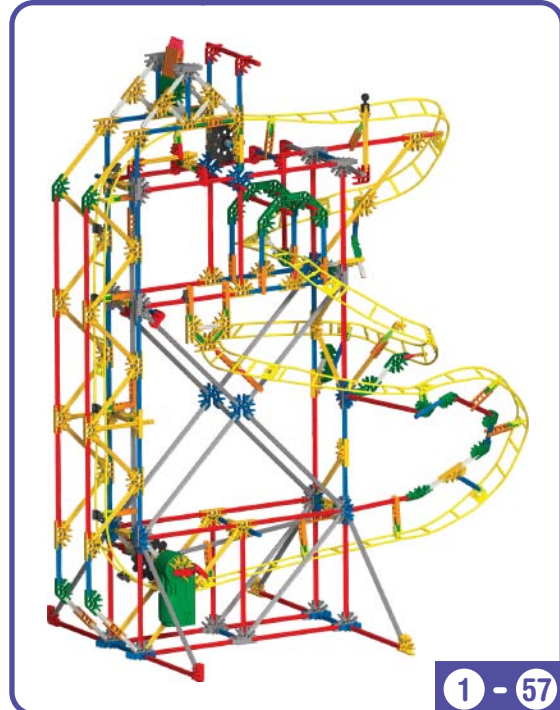

1 - 57

Attaching Chain Links

IMPORTANT:

Attach all the chain links in the same direction.



58



x10

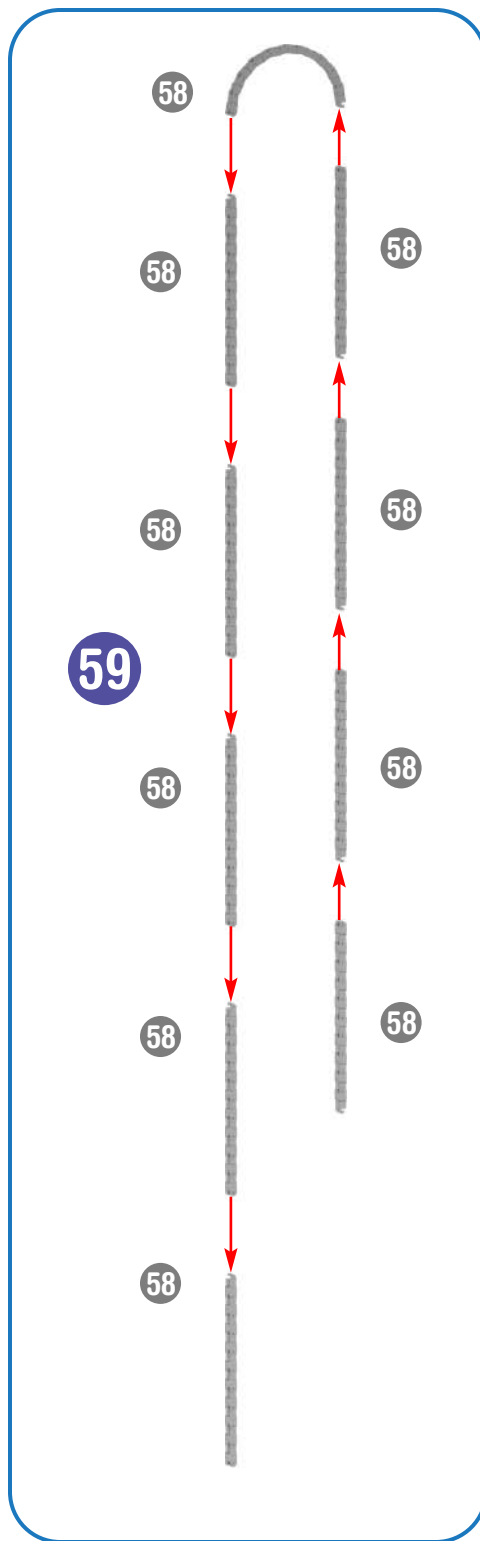

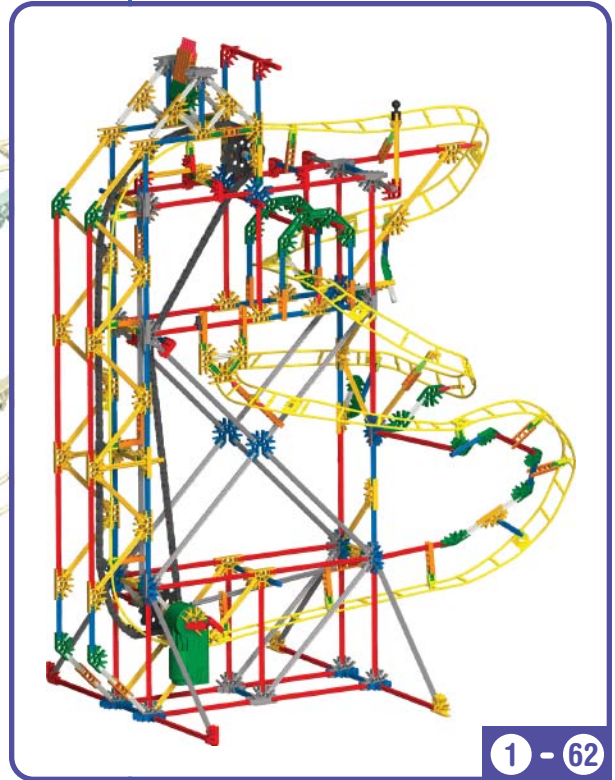
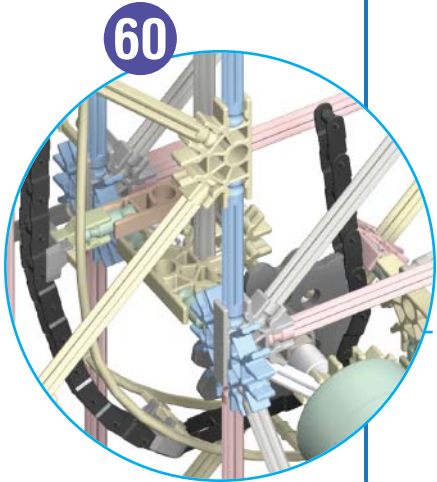
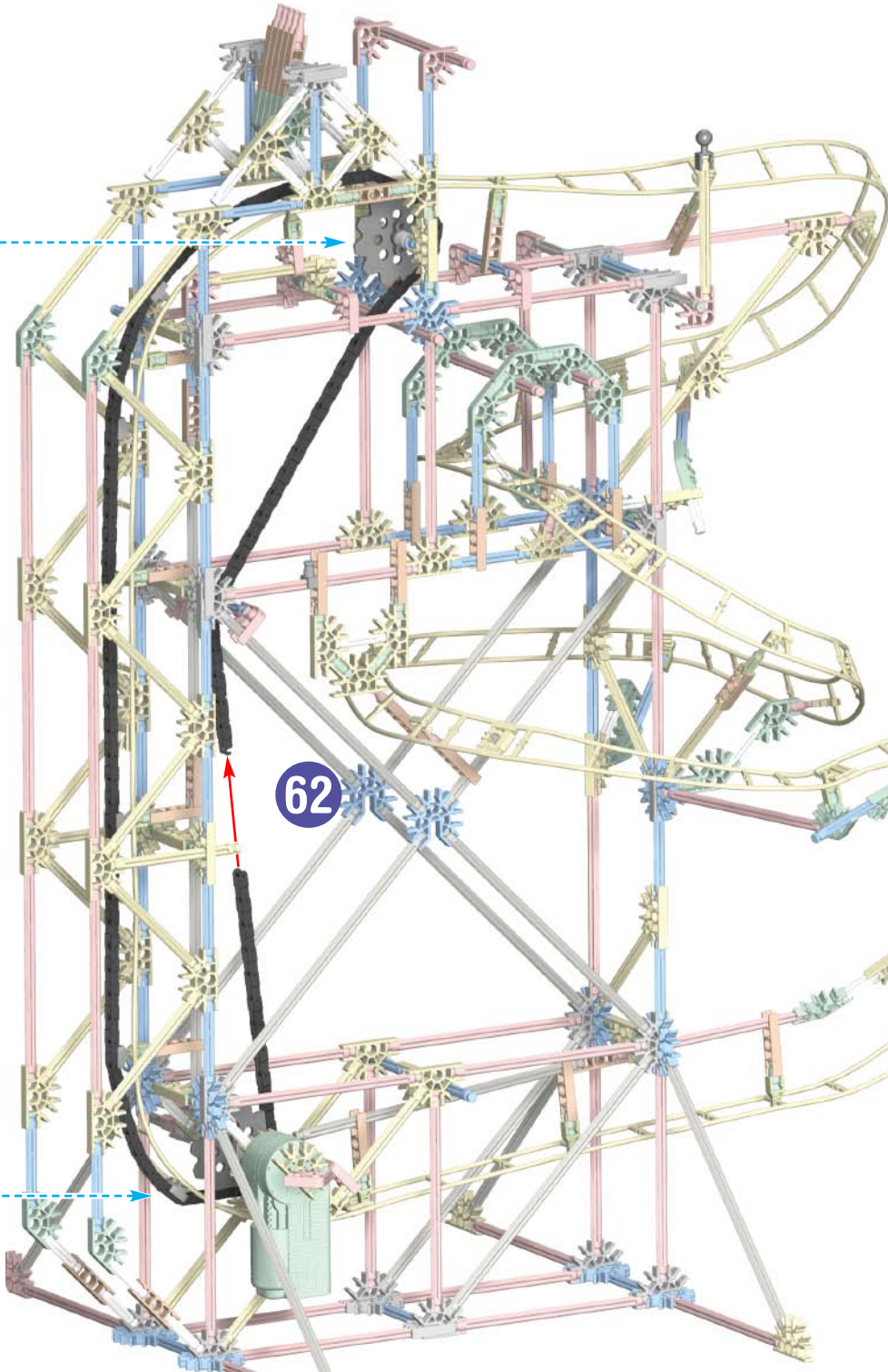
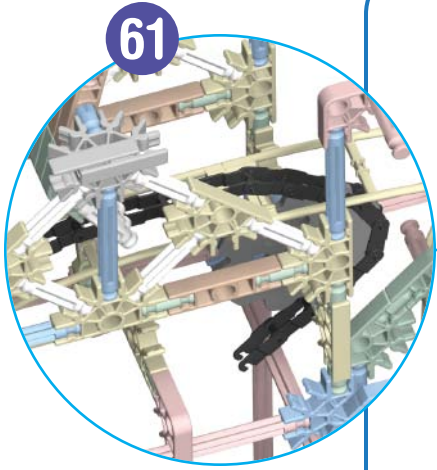

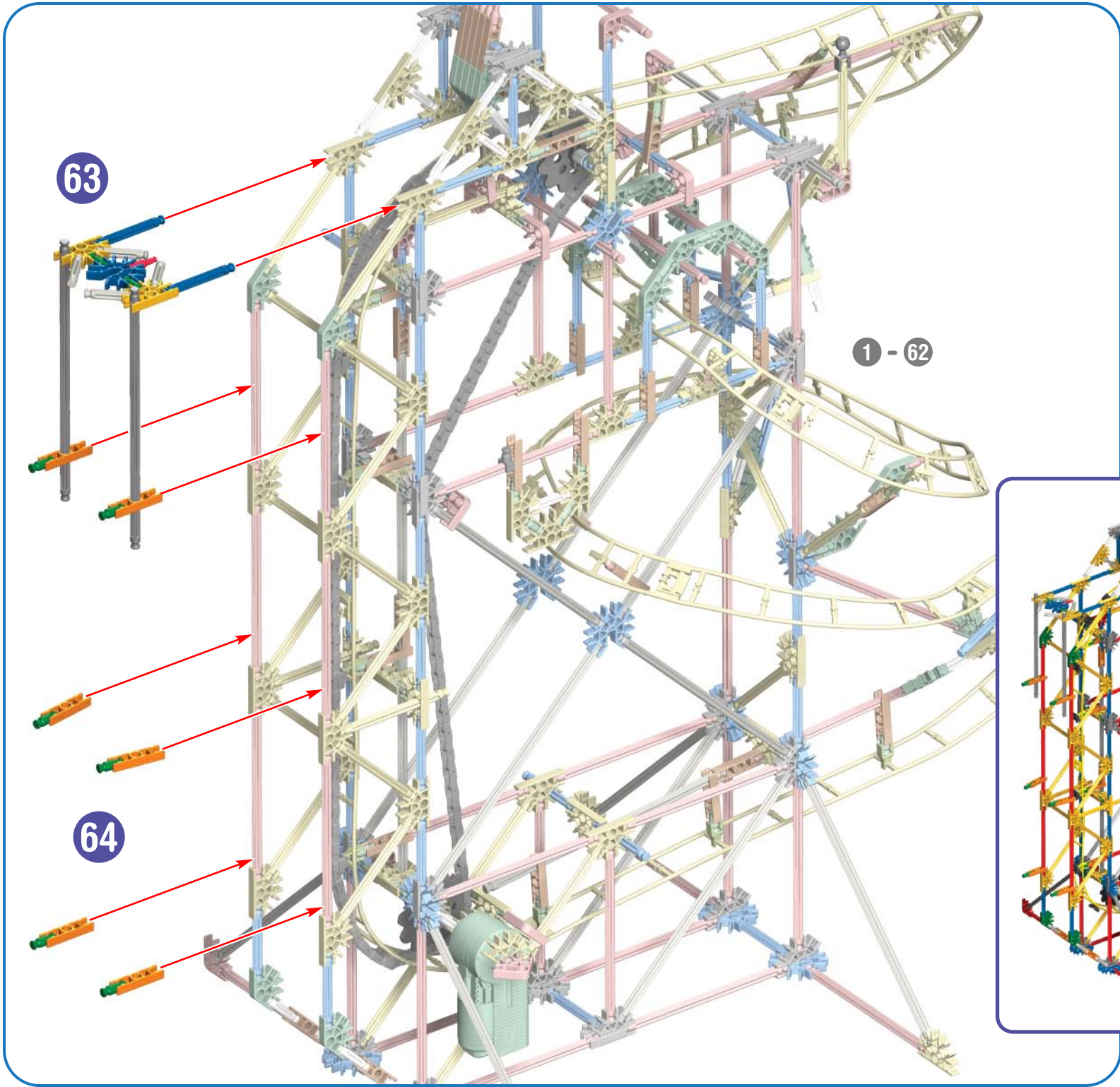

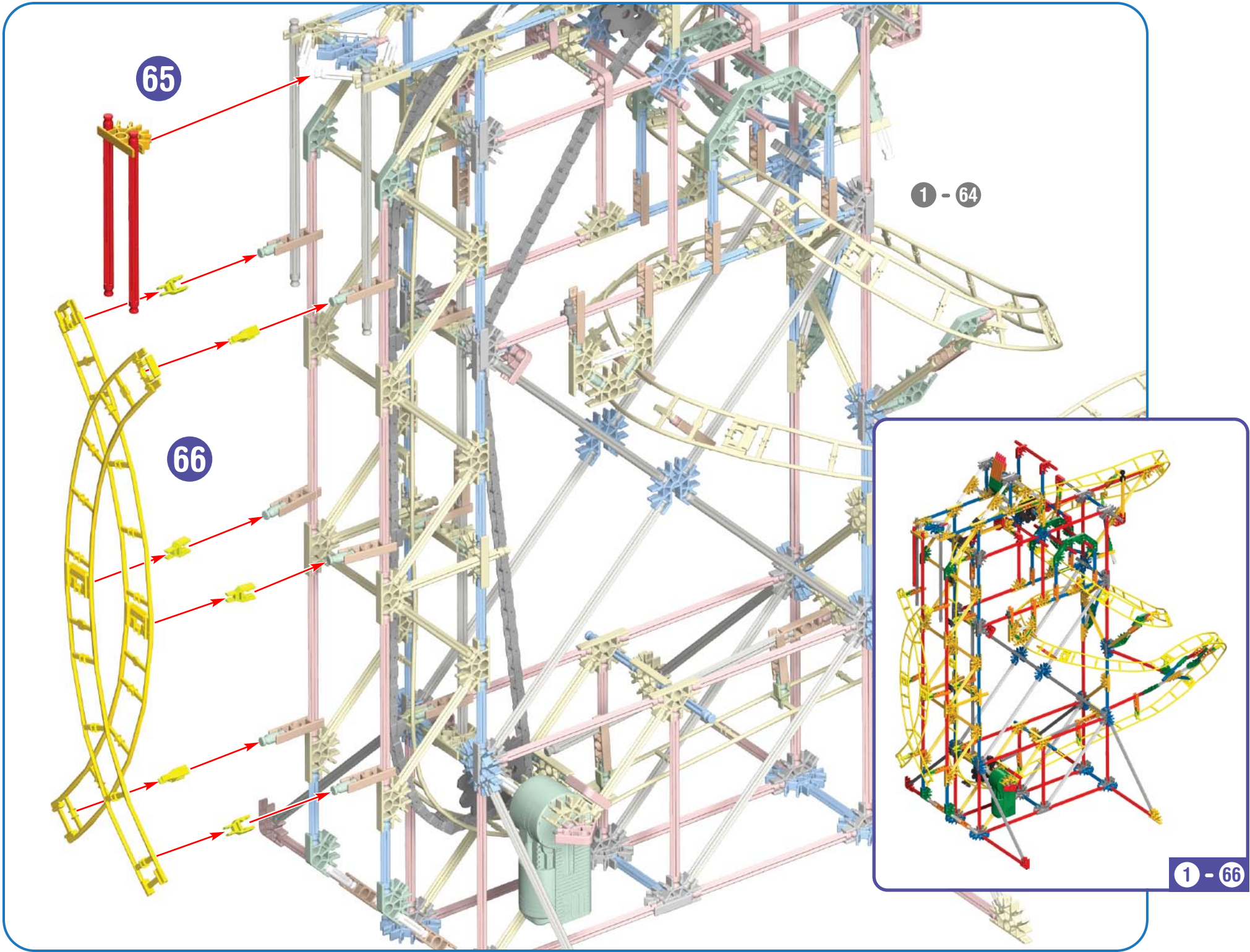

65

1 - 64

66

1 - 66

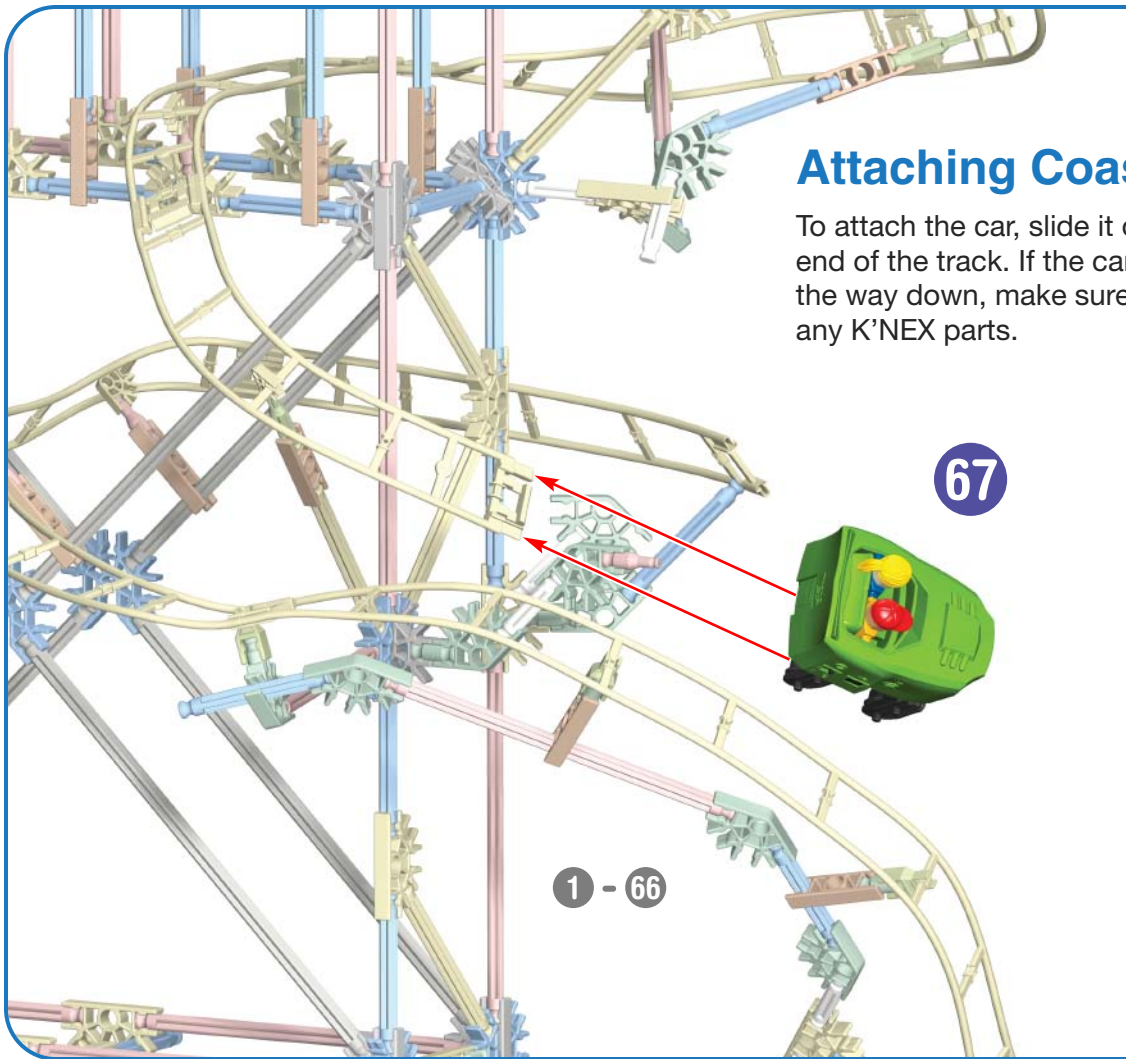

Attaching Coaster Car

To attach the car, slide it onto an open end of the track. If the car gets stuck on the way down, make sure it is not hitting any K'NEX parts.

